



PRODUCT CATALOGUE - PRICE LIST

# LABORATORY GLASSWARE

A COMPLETE LABORATORY SOLUTION

**SHREE SAI SCIENTIFIC**



[www.shreesaiscientific.in](http://www.shreesaiscientific.in)

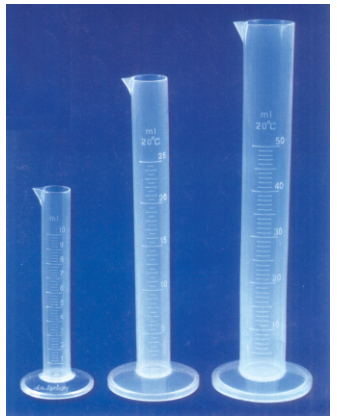
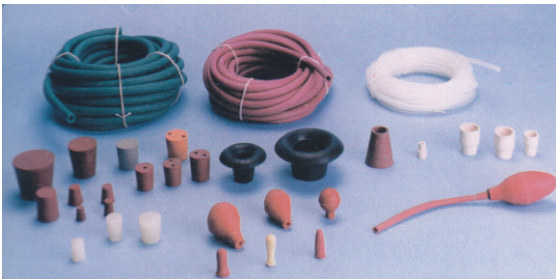
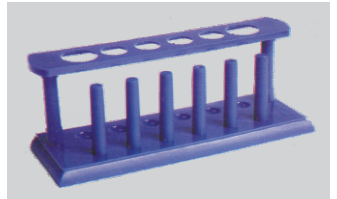
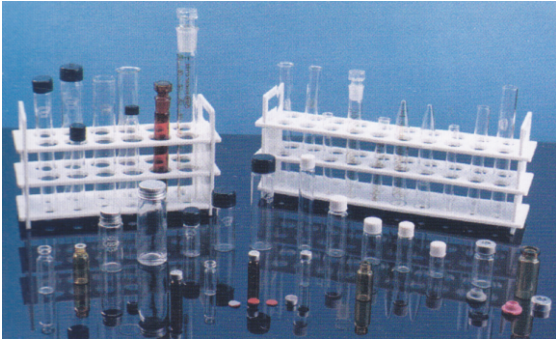
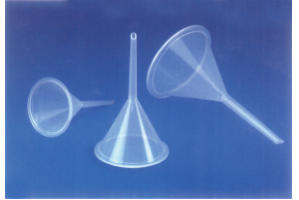
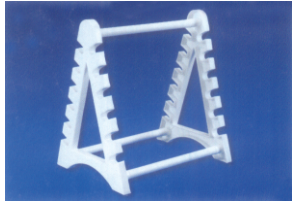



## INTRODUCTION - ORGANISATION PROFILE

"Shree Sai Scientific" is a conglomerate of well experienced, qualified and competent people who has done pioneering work in quality control, laboratory-research and development in industrial process industries.

"Shree Sai Scientific" has developed range of products in glass and non glass equipments and components based on customers' requirements in general and specific. Some of the products have been developed on concept basis of various customers. Thus "Shree Sai Scientific" not only supplies products but provides solution also; it has a backup of efficient after sales support and dedicated division of marketing & sales team, accounts & finance and administration.

We are dealing with many Government, Semi Government, Academic Institutions, NGOs and also our Prime Customers undertaking for supplying Laboratory Items, Analar Reagents & Chemicals in various grades and also Industrial Glass Equipments on Regular basis.

"Shree Sai Scientific" is expanding and making penetration all over India with the nomination of agents and distributor networking.





## WHO AM I ?

- G I am created of the admixture of Earth's minerals, formed by the alchemy of time. I am born transformed in the blasting heat of fiery furnace.
- G I am molten mass I am tediously fashioned by the hand of cunning Artisans - or fed into the maw of intricate machine.
- G I assume ten thousand hues of all the spectrum - either transparent, translucent or opaque - upon my maker's will.
- G I can masquerade as ruby - emerald - topaz - moonstone; and all other priceless jewels of man. But frivolous baubles are not my aspiration - I serve ten million purposes in as many places, forms and ways.
- G My duties are unnumbered - infinite; pay heed to my utility.
- G I admit the Heavenly light to hovel, palace or cathedral, and yet repel cold winter's howling breath.
- G I faithfully project the light that warns great ships from shoal and concentrate the beam that guide swift vehicle through storm and gloom of night to bring the wayfarer safe home.
- G I visibly contain my master's food - his drink - and countless other of his commodities; protecting them in transport and in the mart and home.
- G I form the glowing shell of bulb and tube to diffuse his artificial light and to disseminate his advertising. I am the walls of his abode, his office and his factory - and objects of utility and art in each of these.
- G I reflect his image - and mark the effects of time upon his person sometimes I flatter but more often am critically severe.
- G I correct his impaired sight and thus bestow enjoyment of the printed word and all of Nature's beauties roundabout.
- G I magnify his minute, unseen enemies and thereby do I promote his health and happiness.
- G I form the gossamer thread from which is fashioned fine raiment - yet too the insulation of his dwelling
- G I reveal to him the mysteries of his Universe - carrying his vision to the illimitable reaches of the outer stars.
- G Through me he learned to chart the Firmament - to plot the orbits of the Planets and predict the courses of the Comets and Eclipses.
- G This knowledge I unfold is but the pledge of vaster knowledge as - step by step - I lead him to unexplored, immeasurable spaces.
- G For I am older than the pyramids yet newer than tomorrow's unborn dawn - withal the marks of time affects me not - for I am ageless and retain my lustrous beauty permanently. Some of my tasks I have recounted - but this is only the beginning; for those who made me and adapt me to their uses are men of vision and together, and times unfolds, we will go far.
- G And so - in modesty I proclaim - I am Man's invaluable and versatile servant  
IAM GLASS.



## TECHNICAL INFORMATION

---

Laboratory works require apparatus made in a Borosilicate 3.3 expansion glass which offers maximum inertness to widest range of chemical substances, withstand thermal shock, high temperature without deforming and resilient enough to withstand the normal laboratory handling, washing and sterilizing processes.

Borosilicate glass represents unmatched standardized glass for construction of Laboratory Glasswares. Its steadily growing use is due to many advantages over conventional materials.

- \* Outstanding corrosion resistance
- \* Smooth pore and surface.
- \* Transparency
- \* Catalytic, inertness
- \* No effect on taste and odour
- \* Physiological inertness

Borosilicate glass is chosen for its unique chemical and physical properties. Borosilicate glass can be considered as being composed of oxides. Silica ( $\text{SiO}_2$ ), boric oxide ( $\text{B}_2\text{O}_3$ ) and phosphorous pentoxide ( $\text{P}_2\text{O}_5$ ) are chief glass form oxides. Soda ( $\text{Na}_2\text{O}$ ), Lime ( $\text{CaO}$ ), Alumina ( $\text{Al}_2\text{O}_3$ ) Potash ( $\text{K}_2\text{O}$ ) Magnesia ( $\text{MgO}$ ) and lead oxide ( $\text{PbO}$ ) are the principle modifiers/fluxes.

### CHEMICAL COMPOSITION

The composition of borosilicate glass used has following approximate composition.

|                               |                                 |
|-------------------------------|---------------------------------|
| $\text{SiO}_2$ - 80.6 %       | $\text{B}_2\text{O}_3$ - 12.5%  |
| $\text{Na}_2\text{O}$ - 4.5 % | $\text{Al}_2\text{O}_3$ - 2.2 % |

### RESISTANCE TO CHEMICALS

Borosilicate glass is inert to almost all materials except hydrofluoric acid (HF) phosphoric acid ( $\text{H}_3\text{PO}_4$ ) and hot strong caustic solutions. Of these, Hydrofluoric acid has the most serious effect, even when it is present in PPM (parts per million) in solutions, Whereas phosphoric acid and caustic solutions cause no problems when cold but at elevated temperature corrosion occurs. In case of caustic solutions upto 30% concentration can be handled safely at ambient temperature.

Under actual operating conditions, the effect of turbulence, and traces of other chemicals in the solution may increase or decrease the rate of attack. So it is not possible to give exact figures for corrosion by caustic solutions.

### THERMAL PROPERTIES

Linear coefficient of thermal expansion the coefficient of thermal expansion of borosilicate glass over the temperature 0-300 °C is  $33 \times 10^{-7} / ^\circ\text{C}$ . This is very low when compared with other glasses and metals. That is why borosilicate glass is often called low expansion borosilicate glass.



## **SPECIFIC HEAT**

Specific heat between 25°C and 300 °C is average to be 0.233Kcal/Kg °C.

## **THERMAL CONDUCTIVITY**

Thermal conductivity is 1.0 Kcal/hr. m°C over the permissible operating temperature range.

## **ANNEALING**

Annealing of glass is the process where the glass is heated and kept for a defined period of time to relieve internal stresses. Careful cooling under controlled conditions is essential to ensure that no stresses are reintroduced by chilling/cooling.

## **MECHANICAL PROPERTIES**

The lack of ductility of glass prevents the equalization of stresses at local irregularities or flaws and the breakage strength varies considerably about a mean value. This latter is found to occur at a tensile strength of about 700kgs/cm.

In order to allow for the spread of breaking stress, a large factor of safety is applied when determining the wall thickness requirement to allow operation up to specified limit of working pressure.

## **OPTICAL PROPERTIES**

Borosilicate glass shows no appreciable absorption in the visible region of spectrum and therefore appears clear and colorless. In photo chemical process the transparency of ultra violet is of particular importance. It follows from the transmittance of material in UV region that photochemical reactions such as chlorination & sulpho -chlorination can be performed in it.



# INDEX

## A

|  |    |
|--|----|
| ADAPTER CONE, RIGHT ANGLE CONNECTION                           | 48 |
| ADAPTER RECEIVER BENDS WITH MULTIPLE CONNECTION SOCKET TO CONE | 49 |
| ADAPTER RECEIVER BENDS WITH VACUUM CONNECTION SOCKET TO CONE   | 47 |
| ADAPTER RECEIVER BENDS WITH VENT, SOCKET TO CONE               | 47 |
| ADAPTER RECEIVER, PLAIN BEND, SHORT                            | 47 |
| ADAPTER RECEIVER, STRAIGHT DELIVERY                            | 48 |
| ADAPTERS, ENLARGING, INTERCHANGEABLE JOINTS                    | 52 |
| ADAPTERS, REDUCING, INTERCHANGEABLE JOINTS                     | 52 |
| AERATION TUBE / OXYGEN TUBE                                    | 68 |
| AIR CONDENSER CONE ONLY  | 23 |
| AMMONIA DISTILLING APPARATUS WITH GRAHAM CONDENSER             | 70 |
| AMPULES AMBER NEUTRAL GLASS PACK OF 1000 PCS                   | 79 |
| AMPULES NEUTRAL GLASS PACK OF 1000 PCS                         | 79 |
| ARSENIC DETERMINATION APPARATUS WITH INDIAN GLASS BOTTLE       | 69 |

## B

|   |    |
|---|----|
| BALANCE ELECTRONIC                                    | 79 |
| BEAKERS BERZELIUS, TALL FORM, WITHOUT SPOUT           | 12 |
| BEAKERS GRIFFIN, LOW FORM, WITH SPOUT, GRADUATED      | 12 |
| BOSS HEAD WITH DOUBLE KEY                             | 73 |
| BOTTLE DROPPING, INDIAN GLASS, T. K. PATTERN          | 13 |
| BOTTLE DROPPING, WITH GROUND IN PIPETTE & RUBBER TEAT | 13 |
| BOTTLE ONLY FOR WASH BOTTLES                          | 17 |
| BOTTLE SCREW CAP AMBER COLOUR GRADUATED               | 15 |
| BOTTLE SCREW CAP PLAIN GRADUATED                      | 15 |
| BOTTLE, ONLY FOR GAS WASHING BOTTLES                  | 18 |
| BOTTLE, RELATIVE DENSITY, WITH GLASS CAPILLARY        | 37 |
| BOTTLE, SPECIFIC GRAVITY WITH THERMOMETER             | 37 |
| BOTTLE, WOULF THREE NECKS                             | 17 |
| BOTTLES WASH, COMPLETE WITH INTERCHANGEABLE STOPPER   | 17 |
| BOTTLES, ASPIRATOR WITH OUTLET FOR STOPPER            | 13 |
| BOTTLES, ASPIRATOR WITH OUTLET FOR TUBING             | 12 |
| BOTTLES, ASPIRATOR, WITH I/C STOPPER AND STOPCOCK     | 13 |
| BOTTLES, B.O.D. WITH INTERCHANGEABLE STOPPER          | 13 |



|   |    |
|---|----|
| BOTTLES, GAS WASHING, COMPLETE WITH I/C STOPPER                   | 17 |
| BOTTLES, REAGENT, AMBER NARROW MOUTH, WITH I/C STOPPER            | 16 |
| BOTTLES, REAGENT, PLAIN NARROW MOUTH, WITH I/C STOPPER            | 15 |
| BOTTLES, SOLUTION, AMBER TOOLED NECK                              | 16 |
| BOTTLES, SOLUTION, PLAIN TOOLED NECK                              | 16 |
| BOTTLES, WEIGHING WITH INTERCHANGEABLE STOPPER                    | 15 |
| BOTTOM ONLY FOR KETTLES   | 33 |
| BUNSEN BURNER BRASS   | 76 |
| BURETTE CLAMP, FISHER TYPE, (HOLDER)                              | 72 |
| BURETTE STAND CAST IRON WITH ROD                                  | 72 |
| BURETTES, AMBER COLOR AUTOMATIC ZERO, RESERVOIR CLASS 'A'         | 21 |
| BURETTES, AUTOMATIC ZERO, AMBER WITH RESERVOIR. CLASS : B         | 21 |
| BURETTES, AUTOMATIC ZERO, MOUNTED ON RESERVOIR CLASS 'A'          | 20 |
| BURETTES, AUTOMATIC ZERO, MOUNTED ON RESERVOIR CLASS B            | 20 |
| BURETTES, PINCH TYPE WITH RUBBER TUBE & METAL CLIP                | 19 |
| BURETTES, ROTAFLO, STOPCOCKS WITH PTFE KEYS, CLASS B              | 19 |
| BURETTES, ROTAFLOW, CLASS 'A' WITH WORK CERTIFICATE               | 19 |
| BURETTES, STRAIGHT BORE PTFE KEY STOPCOCK, CLASS B                | 20 |
| BURETTES, STRAIGHT BORE STOPCOCK, CLASS 'A'                       | 20 |
| BURETTES, STRAIGHT BORE STOPCOCK, CLASS B                         | 19 |
| <b>C</b>  |    |
| CALCIUM CHLORIDE CYLINDER (TOWER) WITH SIDE TUBES AND I/C STOPPER | 63 |
| CALCIUM CHLORIDE, DRYING TUBE / GUARD TUBE                        | 48 |
| CANNULAE SYME'S / CANNULAE VENOUS                                 | 68 |
| CARBON DIOXIDE APPARATUS SCHRODTER'S                              | 18 |
| CHROMATOGRAPHY APPARATUS  | 69 |
| CHROMATOGRAPHY COLUMN PLAIN WITH GLASS STOPCOCK                   | 24 |
| CHROMATOGRAPHY COLUMN PLAIN, WITH SINTERED DISC                   | 24 |
| CHROMATOGRAPHY COLUMN PLAIN, WITH SINTERED DISC, W/O STOPCOCK     | 24 |
| CLAY PIPE TRIANGLES PORCELAIN                                     | 80 |
| CLIP FOR SPHERICAL BALL & SOCKET JOINTS                           | 83 |
| COUPLING JAR  | 82 |
| COLUMN FRACTIONATING, VIGREUX                                     | 22 |
| COMPLETE EXTRACTION APPARATUS                                     | 28 |
| CONDENSER & FLASK CLAMP WITHOUT BOSS HEAD                         | 73 |
| CONDENSER DOUBLE SURFACE (DAVIES)                                 | 22 |



|  |    |
|--|----|
| CONDENSER JACKETED COIL  | 22 |
| CONDENSER LIEBIG WITH SEALED INNER TUBE                          | 21 |
| CONDENSER ONLY FOR EXTRACTION APPARATUS, ALLIHN                  | 28 |
| CONDENSER, FREDRICH'S, DRIP TIP, I/C INNER & I/C OUTER JOINT     | 23 |
| CONDENSER. COIL DISTILLATE                                       | 23 |
| CONDENSERS, GRAHAM, COILED WATER IN COIL, DRIP TIP               | 22 |
| CONE PLAIN AND DOUBLE  | 53 |
| COVERS ONLY FOR KETTLES  | 33 |
| CROW RECEIVER CYLINDER   | 26 |
| CRUCIBLE WITH LID, PORCELAIN                                     | 46 |
| CYLINDERS, GRADUATED, SINGLE METRIC, HEXAGONAL BASE              | 26 |
| CYLINDERS, GRADUATED, SINGLE METRIC, I/C STOPPER, HEXAGONAL BASE | 26 |
| CYLINDERS, MEASURING WITH ROUND BASE CLASS 'A'                   | 25 |
| CYLINDERS, MEASURING WITH ROUND BASE CLASS B                     | 25 |
| CYLINDERS, NESSLER, COLOUR COMPARISON, FLAT BOTTOM               | 26 |
| <b>D</b>   |    |
| DEAN AND STARK APPARATUS LIGHT ENTRAINER                         | 63 |
| DESICCATORS, VACUUM, WITH TUBULATED COVER, STOPPER, PTFE SPINDLE | 27 |
| DESICCATORS, WITH COVER, KNOB TOP                                | 27 |
| DIGITAL STOP WATCH   | 78 |
| DISHES, CRYSTALLIZING  | 27 |
| DISHES, PETRI, CULTURE PLATES                                    | 27 |
| DISTILLATION APPARATUS (BOROSILICATE GLASS WITH S.S. HEATER)     | 64 |
| DISTILLATION ASSEMBLY.   | 71 |
| DRUM PIPETTE   | 46 |
| DURHAM TUBES / FERMENTATION TUBES                                | 55 |
| <b>E</b>   |    |
| EVAPORATING DISHES, WITH SPOUT                                   | 61 |
| EVAPORATING BASIN (CHINA DISHES) PORCELAIN                       | 81 |
| EXTRACTORS, ONLY SOXHLET, INTERCHANGEABLE JOINT                  | 28 |
| E.S.R. TUBE  | 83 |
| E.S.R. STAND   | 83 |
| <b>F</b>   |    |
| FILTER FUNNEL, FUNNEL CUM TEST TUBE WITH HOLE                    | 40 |
| FILTER PAPER 500 SHEETS (REAM)                                   | 78 |
| FILTER PUMP, COLLEGE PATTERN                                     | 42 |



|  |    |
|--|----|
| FLASK, FLAT BOTTOM, BOILING, FLORENCE                                    | 29 |
| FLASK, FOUR NECKS, ROUND BOTTOM, CENTER NECK & THREE PARALLEL SIDE NECKS | 32 |
| FLASK, HAFFKINE, CULTURE   | 32 |
| FLASK, ROUND BOTTOM, BOILING   | 29 |
| FLASK, THREE NECKS, ROUND BOTTOM, CENTER NECK & TWO ANGLE SIDE NECKS     | 31 |
| FLASK, THREE NECKS, ROUND BOTTOM, CENTER NECK & TWO PARALLEL SIDE NECKS  | 32 |
| FLASK, TWO NECKS, ROUND BOTTOM, CENTER NECK & ONE ANGLE NECK             | 31 |
| FLASK, TWO NECKS, ROUND BOTTOM, CENTER NECK & ONE PARALLEL SIDE NECK     | 31 |
| FLASKS, BOILING, PEAR SHAPED, SHORT NECK, WITH I/C JOINT                 | 29 |
| FLASKS, CONICAL B 24, AUTOMATIC TILT MEASURE WITH I/C RESERVIOR          | 37 |
| FLASKS, CONICAL ERLNMEYER, GRADUATED, NARROW MOUTH                       | 36 |
| FLASKS, CONICAL, ERLNMEYER, GRADUATED, AMBER WITH NARROW MOUTH           | 36 |
| FLASKS, CONICAL, ERLNMEYER, NARROW MOUTH, WITH I / C STOPPER             | 37 |
| FLASKS, CONICAL, ERLNMEYER, WIDE MOUTH                                   | 36 |
| FLASKS, DISTILLING, WITH SIDE ARM  | 30 |
| FLASKS, FILTERING HEAVY WALL, BOLT NECK WITH TUBULATION                  | 38 |
| FLASKS, FLAT BOTTOM, BOILING, SHORT NECK, I / C JOINT                    | 30 |
| FLASKS, IODINE DETERMINATION, INTERCHANGEABLE STOPPER                    | 38 |
| FLASKS, KHJELDAHL, ROUND BOTTOM, INTERCHANGEABLE JOINT                   | 33 |
| FLASKS, KHJELDAHL, ROUND BOTTOM, LONG NECK                               | 33 |
| FLASKS, ROUND BOTTOM, BOILING, SHORT NECK, WITH I/C JOINT                | 30 |
| FLAT FLANGE JOINT CLIP   | 35 |
| FUNNEL WITH THISTLE HEAD   | 41 |
| FUNNEL, PRESSURE EQUILIZING, GRADUATED WITH GLASS/PTFE STOPCOCK          | 43 |
| FUNNEL, SEPARATING, GLOBE SHAPE, STOPCOCK & STOPPER                      | 41 |
| FUNNEL, SEPARATING, PEAR SHAPE, GLASS STOPCOCK & STOPPER                 | 42 |
| FUNNEL, SEPARATING, PEAR SHAPE, HOLLOW PLUG STOPCOCK & STOPPER           | 42 |
| FUNNEL, SEPARATING, PEAR SHAPE, PTFE KEY STOPCOCK & STOPPER              | 42 |
| FUNNELS, ADDITION / DROPPING, CYLINDRICAL WITH CONE, OPEN TOP            | 43 |
| FUNNELS, BUCHNER POECELAIN   | 41 |
| FUNNELS, BUCHNER STAINLESS STEEL   | 41 |
| FUNNELS, BUCHNER TYPE, WITH SINTERED DISC                                | 23 |



|   |    |
|---|----|
| FUNNELS, CYLINDRICAL, GRADUATED WITH CONE SOCKET & GLASS STOPCOCK | 43 |
| FUNNELS, PLAIN, 60 DEGREE ANGLE LONG STEM                         | 40 |
| FUNNELS, POWDER, SHORT STEM                                       | 40 |
| FUNNELS, POWDER, SHORT STEM WITH CONE                             | 40 |
| FORCEPS STRAIGHT / BLUNT S.S.                                     | 82 |
| FUSION TUBES / IGNITION TUBES, NEUTRAL GLASS                      | 55 |
| <b>G</b>  |    |
| GAS SAMPLING, TUBES, STRAIGHT BORE STOPCOCK                       | 18 |
| GLASS BEADS WITHOUT HOLE  | 67 |
| GLASS MERCURY SEAL GLAND WITH TEFLON / PTFE, 'O' RING             | 56 |
| GLASS RODS WITH ROUND ENDS, 300 MM LONG                           | 58 |
| GLASS SPRADERS TRIANGULAR BEND TYPE                               | 71 |
| GOOCH CRUCIBLE, LOW FORM, WITH SINTERED DISC                      | 46 |
| <b>H</b>  |    |
| HEATING MANTLE WITH ENERGY REGULATOR AND PILOT LAMPS              | 66 |
| HOFFMAN SCREW CLIP BRASS NICKEL PLATED                            | 76 |
| HYDROMETER SPECIFIC GRAVITY, 100 RANGE DIVIDED IN 100 DIVISION    | 59 |
| HAEMOCYTOMETER  | 83 |
| HAND GLOVES, RUBBER   | 81 |
| HAND GLOVES, ASBESTOS   | 81 |
| <b>I</b>  |    |
| IMPINGER GRADUATED FOR AIR SAMPLING                               | 79 |
| <b>J</b>  |    |
| JACKETED REACTION KETTLES   | 34 |
| JARS, BELL, ROUND BOTTOM, EDGE GROUND                             | 35 |
| JARS, CYLINDRICAL, FERMENTATION                                   | 35 |
| <b>K</b>  |    |
| KETTLES, RESIN REACTION   | 34 |
| KIPPS APPARATUS, GAS GENERATOR                                    | 60 |
| <b>L</b>  |    |
| LABORATORY JACKS BOX TYPE HEAVY DUTY M.S.                         | 74 |
| LABORATORY THERMOMETERS   | 58 |
| LIDS FOR REACTION FLASKS FLAT FLANGE AND I / C JOINT              | 34 |
| LIEBIG CONDENSER WITH I/C JOINT                                   | 21 |
| LOOP HOLDER   | 75 |
| <b>M</b>  |    |



|  |    |
|--|----|
| MANOMETER 'U' TUBE CAPILLARY WITH SCALE ON WOODEN BOARD                |    |
| WITHOUT MERCURY  | 60 |
| MANOMETER 'U' TUBE CAPILLARY WITHOUT SCALE & MERCURY                   | 60 |
| MC CLEOD GAUGE (VACUSTAT) COMPLETE WITH STAND AND<br>DISTILLED MERCURY | 60 |
| MELTING POINT TUBES / CAPILLARY TUBE                                   | 58 |
| MICRO KJELDAHL DISTILLATION ASSEMBLY, WITH SPECIAL JOINTS              | 65 |
| MICRO KJELDAHL DISTILLATION APPARATUS                                  | 70 |
| MICRO PIPETTES FIXED VOLUME  | 80 |
| MICRO PIPETTES VARIABLE VOLUME   | 80 |
| MICROSCOPIC COVER GLASSES  | 66 |
| MICROSCOPIC GLASS SLIDES   | 67 |
| MILLIPORE ASSEMBLY, MEMBRANE, VACUUM FILTER, (SINTERED ASSEMBLY)       | 59 |
| MORTER & PESTLE (INDIAN GLASS)   | 68 |
| MORTER & PESTLE (PORCELAIN)  | 68 |
| MULTIPLE ADAPTER WITH THREE NECK, TWO PARALLEL AND ONE AT ANGLE        | 50 |
| MULTIPLE ADAPTER WITH TWO NECKS, ONE VERTICAL AND OTHER ANGLE          | 52 |
| MULTIPLE ADAPTERS WITH TWO PARALLEL NECKS                              | 51 |
| MUSEUM JARS  | 35 |
| <b>O</b>   |    |
| OIL BATH DOUBLE WALLED THERMOSTATIC, ELECTRICALLY OPERATED             | 66 |
| OIL DETERMINATION APPARATUS (CLEVANGER) HEAVIER THAN WATER             | 63 |
| OIL DETERMINATION APPARATUS (CLEVANGER) LIGHTER THAN WATER             | 63 |
| ORGAN TUBE WITH SIDE TUBE / ORGAN TUBE WITHOUT SIDE TUBE               | 68 |
| <b>P</b>   |    |
| PASTEUR OR TRANSFER PIPETTES   | 45 |
| PERKIN'S RECEIVER ADAPTER INTERMEDIATE WITH GLASS STOPCOCK             | 59 |
| PINCH CLIP   | 76 |
| PIPELINE, FILTERS, DOUBLE DRAWN, WITH SINTERED DISC                    | 25 |
| PIPETTE BULB RUBBER RED COLOUR   | 77 |
| PIPETTES DROPPING  | 45 |
| PIPETTES, VOLUMETRIC, TRANSFER. CLASS A WITH WORK CERTIFICATE          | 45 |
| PIPETTES, MEASURING (MOHR TYPE) CLASS A                                | 44 |
| PIPETTES, MEASURING (MOHR TYPE) CLASS B                                | 44 |
| PIPETTES, SEROLOGICAL CLASS B  | 44 |
| PIPETTES, VOLUMETRIC, TRANSFER. CLASS B                                | 45 |



|   |    |
|---|----|
| PH PAPER  | 83 |
| PRESSURE RUBBER TUBING (GREEN / RED COLOR) MINIMUM 10 MTR. ROLL           | 74 |
| PYKNO METERS  | 65 |
| <b>R</b>  |    |
| RASCHING RINGS FOR PACKING COLUMNS NEUTRAL GLASS                          | 67 |
| RBC PIPETTE   | 78 |
| REAGENT BOTTLE NARROW MOUTH, INDIAN GLASS, AMBER COLOUR                   | 14 |
| REAGENT BOTTLE NARROW MOUTH, INDIAN GLASS, PLAIN                          | 14 |
| REAGENT BOTTLE WIDE MOUTH, INDIAN GLASS, AMBER COLOUR                     | 14 |
| REAGENT BOTTLE WIDE MOUTH, INDIAN GLASS, PLAIN                            | 14 |
| REFLUX DEVIDER HEAD UNIVERSAL   | 61 |
| RETORT RINGS  | 73 |
| ROTARY EVAPORATOR INBUILT VACUUM GAUGE SYSTEM, VERTICAL<br>HEAT EXCHANGER | 64 |
| ROTARY FLASK (BUCHI TYPE)   | 28 |
| ROTARY VACUUM EVAPORATOR SYSTEM   | 64 |
| RUBBER ADAPTOR FOR FILTER FLASK   | 77 |
| RUBBER BULB FOR AUTOMATIC BURETTES (SINGLE BELLOW)                        | 77 |
| RUBBER CONES  | 77 |
| RUBBER CORKS  | 78 |
| <b>S</b>  |    |
| SILICA CRUCIBLES LOW FORM (TRANSLUCENT, INDIAN MAKE)                      | 46 |
| SOCKET PLAIN AND DOUBLE   | 53 |
| SOLID POWDER ADDITION FUNNEL WITH TEFLON SCREW COCK                       | 62 |
| SPARGER, GAS INLET TUBE, AIRLEAK TUBE / STEAM                             | 51 |
| SPATULA MICRO S.S.  | 75 |
| SPATULAS, WITH ONE SIDE FLAT AND OTHER SIDE SPOON S.S.                    | 75 |
| SPECIMEN JARS, RECTANGULAR WITHOUT COVERS                                 | 65 |
| SPLASH HEAD, PEAR SHAPE, SLOPPING   | 48 |
| SPRAYER FOR CHROMATOGRAPHY WORK   | 62 |
| SPRING BALANCE  | 82 |
| STALAGNOMETER GRADUATED   | 68 |
| STILL HEAD PLAIN, SLOPPING WITH THERMOMETER SOCKET                        | 49 |
| STILL HEAD, ADAPTOR RECOVERY BEND, SLOPPING                               | 50 |
| STILL HEAD, PEAR SHAPE, SLOPPING  | 49 |
| STIRRING ROD, BUTTON TYPE   | 56 |



|  |    |
|--|----|
| STOPPER HEXAGONAL INTERCHANGEABLE GROUND JOINT           | 71 |
| STOPPER HOLLOW PENNY HEAD I/C GROUND JOINT               | 71 |
| STOPPER ONLY FOR GAS WASHING BOTTLES                     | 18 |
| STOPPER ONLY FOR WASH BOTTLES                            | 17 |
| STUFFING BOX GLAND WITH PULLEY MADE OF ALL TEFLON        | 56 |
| STUFFING BOX GLAND, TEFLON (BUSH ONLY)                   | 56 |
| SYRINGE TYPE STIRRER WITH I/C SHAFT FOR HIGH VACUUM      | 62 |
| <b>T</b>   |    |
| TEFLON (PTFE) BLADE TO PASS THROUGH STANDARD I/C JOINT   | 57 |
| TEFLON / PTFE BLADED STIRRER                             | 57 |
| TEFLON / PTFE COATED STIRRING BAR, MAGNETIC ROTORS       | 57 |
| TEST TUBE HOLDER   | 75 |
| TEST TUBE STAND 2 TIRE ALUMINIUM                         | 74 |
| THERMOMETER POCKET, SHORT, TIGHT, CLOSED END             | 58 |
| THIELE'S MELTING POINT TUBE                              | 61 |
| THREE FINGER CLAMP                                       | 73 |
| TISSUE PAPER ROLL  | 77 |
| TLC GLASS PLATE  | 65 |
| TONGS CRUCIBLES IRON (PAIR OF TONG)                      | 75 |
| TOP SCALE ELECTRONIC                                     | 80 |
| TRIPOD STAND, ROUND SHAPE HEAVY INDUSTRIAL TYPE          | 72 |
| TRIPOD STAND, TRIANGULAR SHAPE CAST IRON                 | 72 |
| TRAYS, ENAMEL WITHOUT COVER                              | 81 |
| TUBE TEST GRADUATED WITH I/C STOPPER                     | 54 |
| TUBE, TEST NATURAL GLASS                                 | 55 |
| TUBES CULTURE, MEDIA ROUND BOTTOM WITH SCREW CAP         | 53 |
| TUBES CULTURE, MEDIA, FLAT BOTTOM WITH SCREW CAP         | 53 |
| TUBES TEST, WITH RIM                                     | 54 |
| TUBES TEST, WITHOUT RIM                                  | 54 |
| TUBES, CENTRIFUGE, CONICAL BOTTOM GRADUATED              | 55 |
| TUBES, CENTRIFUGE, CONICAL BOTTOM GRADUATED WITH STOPPER | 55 |
| <b>V</b>   |    |
| VACUUM DRYING PISTOL                                     | 69 |
| VACUUM SUBLIMATION ASSEMBLY                              | 69 |
| VACUUM TRAP WITH I/C JOINT OR W/O JOINT                  | 18 |
| VACUUM PUMP SINGLE STAGE / DOUBLE STAGE                  | 82 |



|  |    |
|--|----|
| VERNIER CALLIPERS  | 82 |
| VESSEL REACTION, WIDE MOUTH, FLAT FLANGE                     | 34 |
| VISCOMETER CANON FENSKS TYPE FOR TRANSPARANT LIQUID          | 61 |
| VISCOMETER COLLEGE PATTERN OSTWALD                           | 62 |
| VOLATILE ACID DETERMINATION APPARATUS                        | 70 |
| VOLUMETRIC FLASK, AMBER COLOUR WITH I/C STOPPER              | 39 |
| VOLUMETRIC FLASK, AMBER COLOUR WITH I/C STOPPER CLASS 'A'    | 39 |
| VOLUMETRIC FLASKS, WITH INTERCHANGEABLE STOPPER CLASS 'A'    | 39 |
| VOLUMETRIC FLASKS, WITH INTERCHANGEABLE STOPPER CLASS B      | 38 |
| <b>W</b>   |    |
| WATCH GLASS, NEUTRAL GLASS                                   | 67 |
| WATER BATH COPPER WITH CENTRE RING                           | 76 |
| WATER BATH FOR ROUND BOTTOM FLASK DOUBLE WALLED THERMOSTATIC | 66 |
| WBC PIPETTE  | 78 |
| WIRE GAUZES  | 76 |

**01****BEAKERS GRIFFIN, LOW FORM, WITH SPOUT, GRADUATED**

| CAT. REF | CAP.  | QTY Per CASE | PRICE/PC |
|----------|-------|--------------|----------|
| 01/01    | 5     | 20           | 40       |
| 01/02    | 10    | 20           | 45       |
| 01/03    | 25    | 72           | 50       |
| 01/04    | 50    | 72           | 51       |
| 01/05    | 100   | 72           | 52       |
| 01/06    | 150   | 80           | 54       |
| 01/07    | 250   | 40           | 58       |
| 01/08    | 400   | 24           | 88       |
| 01/09    | 500   | 24           | 92       |
| 01/10    | 600   | 24           | 95       |
| 01/11    | 1000  | 16           | 192      |
| 01/12    | 2000  | 8            | 370      |
| 01/13    | 3000  | 4            | 960      |
| 01/14    | 5000  | 4            | 1390     |
| 01/15    | 10000 | 2            | 4310     |
| 01/16    | 20000 | 2            | 7600     |

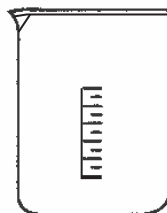
**02****BEAKERS BERZELIUS, TALL FORM, WITHOUT SPOUT**

| CAT. REF | CAP. | QTY Per CASE | PRICE/PC |
|----------|------|--------------|----------|
| 02/01    | 50   | 40           | 72       |
| 02/02    | 100  | 48           | 78       |
| 02/03    | 250  | 36           | 80       |
| 02/04    | 500  | 24           | 124      |
| 02/05    | 1000 | 16           | 254      |

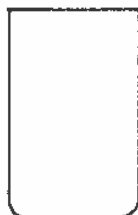
**03****BOTTLES, ASPIRATOR WITH OUTLET FOR TUBING**

| CAT. REF | CAP.  | QTY Per CASE | PRICE/PC |
|----------|-------|--------------|----------|
| 03/01    | 250   | 20           | 200      |
| 03/02    | 500   | 12           | 230      |
| 03/03    | 1000  | 8            | 430      |
| 03/04    | 2000  | 4            | 740      |
| 03/05    | 5000  | 2            | 2610     |
| 03/06    | 10000 | 2            | 4200     |

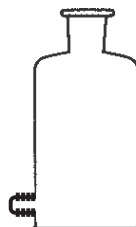



**04**

**BOTTLES, ASPIRATOR WITH OUTLET FOR STOPPER**

| CAT. REF | CAP.  | QTY Per CASE | PRICE/PC |
|----------|-------|--------------|----------|
| 04/01    | 1000  | 8            | 595      |
| 04/02    | 2000  | 4            | 875      |
| 04/03    | 5000  | 2            | 5300     |
| 04/04    | 10000 | 2            | 7500     |
| 04/05    | 20000 | 1            | 12500    |

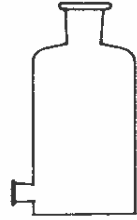

**05**

**BOTTLES, ASPIRATOR, WITH INTERCHANGEABLE STOPPER AND STOPCOCK**

| CAT. REF | CAP.  | QTY Per CASE | PRICE/PC |
|----------|-------|--------------|----------|
| 05/01    | 1000  | 8            | 1800     |
| 05/02    | 2000  | 4            | 2000     |
| 05/03    | 5000  | 2            | 7400     |
| 05/04    | 10000 | 2            | 9900     |
| 05/05    | 20000 | 2            | 12500    |

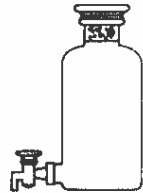

**06**

**BOTTLES, B.O.D. WITH INTERCHANGEABLE STOPPER**

| CAT. REF | CAP. | QTY Per CASE | PRICE/PC |
|----------|------|--------------|----------|
| 06/01    | 125  | 24           | 330      |
| 06/02    | 300  | 40           | 390      |

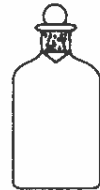

**07**

**BOTTLE DROPPING, WITH GROUND IN PIPETTE & RUBBER TEAT**

| CAT. REF | CAP. | QTY Per CASE | PRICE/PC |
|----------|------|--------------|----------|
| 07/01    | 60   | 12           | 60       |
| 07/02    | 125  | 12           | 70       |



**08**

**BOTTLE DROPPING, INDIAN GLASS, T. K. PATTERN**

| CAT. REF | CAP. | QTY Per CASE | PRICE/PC |
|----------|------|--------------|----------|
| 08/01    | 60   | 12           | 80       |
| 08/02    | 125  | 12           | 100      |





**09**

**REAGENT BOTTLE NARROW MOUTH WITH FLAT STOPPER,  
INDIAN GLASS, PLAIN**

| CAT. REF | CAP. | QTY Per CASE | PRICE/PC |
|----------|------|--------------|----------|
| 09/01    | 60   | 12           | 50       |
| 09/02    | 125  | 12           | 60       |
| 09/03    | 250  | 12           | 80       |
| 09/04    | 500  | 12           | 95       |
| 09/05    | 1000 | 12           | 160      |
| 09/06    | 2000 | 12           | 350      |



**10**

**REAGENT BOTTLE NARROW MOUTH WITH FLAT STOPPER,  
INDIAN GLASS, AMBER COLOUR**

| CAT. REF | CAP. | QTY Per CASE | PRICE/PC |
|----------|------|--------------|----------|
| 10/01    | 125  | 12           | 100      |
| 10/02    | 250  | 12           | 120      |
| 10/03    | 500  | 12           | 150      |
| 10/04    | 1000 | 12           | 280      |



**11**

**REAGENT BOTTLE WIDE MOUTH WITH FLAT STOPPER, INDIAN  
GLASS, PLAIN**

| CAT. REF | CAP. | QTY Per CASE | PRICE/PC |
|----------|------|--------------|----------|
| 11/01    | 60   | 12           | 55       |
| 11/02    | 125  | 12           | 65       |
| 11/03    | 250  | 12           | 90       |
| 11/04    | 500  | 12           | 100      |
| 11/05    | 1000 | 12           | 170      |

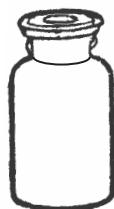

**12**

**REAGENT BOTTLE WIDE MOUTH WITH FLAT STOPPER, INDIAN  
GLASS, AMBER COLOUR**

| CAT. REF | CAP. | QTY Per CASE | PRICE/PC |
|----------|------|--------------|----------|
| 12/01    | 125  | 12           | 140      |
| 12/02    | 250  | 12           | 150      |
| 12/03    | 500  | 12           | 220      |
| 12/04    | 1000 | 12           | 340      |





13

**BOTTLE SCREW CAP PLAIN GRADUATED**

| CAT. REF | CAP. | QTY Per CASE | PRICE/PC |
|----------|------|--------------|----------|
| 13/01    | 100  | 12           | 210      |
| 13/02    | 250  | 12           | 230      |
| 13/03    | 500  | 12           | 290      |
| 13/04    | 1000 | 12           | 430      |
| 13/05    | 2000 | 12           | 670      |

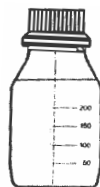

14

**BOTTLE SCREW CAP AMBER COLOUR GRADUATED**

| CAT. REF | CAP. | QTY Per CASE | PRICE/PC |
|----------|------|--------------|----------|
| 14/01    | 100  | 12           | 360      |
| 14/02    | 250  | 12           | 385      |
| 14/03    | 500  | 12           | 450      |
| 14/04    | 1000 | 12           | 595      |
| 14/05    | 2000 | 12           | 1050     |



15

**BOTTLES, WEIGHING WITH INTERCHANGEABLE STOPPER**

| CAT. REF | CAP. | QTY Per CASE | PRICE/PC |
|----------|------|--------------|----------|
| 15/01    | 5    | 24           | 180      |
| 15/02    | 15   | 12           | 200      |
| 15/03    | 20*  | 12           | 410      |
| 15/04    | 25   | 12           | 230      |
| 15/05    | 40*  | 12           | 580      |
| 15/06    | 60   | 6            | 380      |

\* Squat form

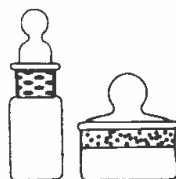

16

**BOTTLES, REAGENT, PLAIN NARROW MOUTH, WITH INTERCHANGEABLE FLAT HEAD STOPPER**

| CAT. REF | CAP.  | QTY Per CASE | PRICE/PC |
|----------|-------|--------------|----------|
| 16/01    | 60    | 24           | 194      |
| 16/02    | 125   | 24           | 200      |
| 16/03    | 250   | 24           | 210      |
| 16/04    | 500   | 12           | 260      |
| 16/05    | 1000  | 8            | 415      |
| 16/06    | 2000  | 4            | 730      |
| 16/07    | 3000  | 4            | 1590     |
| 16/08    | 5000  | 2            | 6790     |
| 16/09    | 10000 | 2            | 9890     |
| 16/10    | 20000 | 2            | 12610    |





17

**BOTTLES, REAGENT, AMBER NARROW MOUTH, WITH INTERCHANGEABLE FLAT HEAD STOPPER**

| CAT. REF | CAP.  | QTY Per CASE | PRICE/PC |
|----------|-------|--------------|----------|
| 17/01    | 60    | 24           | 310      |
| 17/02    | 125   | 24           | 325      |
| 17/03    | 250   | 24           | 390      |
| 17/04    | 500   | 12           | 470      |
| 17/05    | 1000  | 8            | 615      |
| 17/06    | 2000  | 4            | 1050     |
| 17/07    | 3000  | 4            | 2590     |
| 17/08    | 5000  | 2            | 7950     |
| 17/09    | 10000 | 2            | 12250    |
| 17/10    | 20000 | 2            | 15100    |



18

**BOTTLES, SOLUTION, PLAIN TOOLED NECK**

| CAT. REF | CAP.  | QTY Per CASE | PRICE/PC |
|----------|-------|--------------|----------|
| 18/01    | 250   | 24           | 195      |
| 18/02    | 500   | 12           | 210      |
| 18/03    | 1000  | 8            | 365      |
| 18/04    | 2000  | 4            | 635      |
| 18/05    | 3000  | 4            | 1550     |
| 18/06    | 5000  | 2            | 3830     |
| 18/07    | 10000 | 2            | 5500     |
| 18/08    | 15000 | 2            | 8500     |
| 18/09    | 20000 | 2            | 9200     |



19

**BOTTLES, SOLUTION, AMBER TOOLED NECK**

| CAT. REF | CAP.  | QTY Per CASE | PRICE/PC |
|----------|-------|--------------|----------|
| 19/01    | 250   | 24           | 380      |
| 19/02    | 500   | 12           | 425      |
| 19/03    | 1000  | 8            | 630      |
| 19/04    | 2000  | 4            | 1050     |
| 19/05    | 3000  | 4            | 2000     |
| 19/06    | 5000  | 2            | 5900     |
| 19/07    | 10000 | 2            | 7800     |





20

**BOTTLE, WOULD THREE NECKS**

| CAT. REF | CAP. | QTY Per CASE | PRICE/PC |
|----------|------|--------------|----------|
| 20/01    | 250  | 8            | 450      |
| 20/02    | 500  | 8            | 630      |
| 20/03    | 1000 | 8            | 750      |

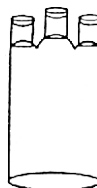

21

**BOTTLES WASH, COMPLETE WITH INTERCHANGEABLE STOPPER**

| CAT. REF | CAP. | QTY Per CASE | PRICE/PC |
|----------|------|--------------|----------|
| 21/01    | 250  | 8            | 410      |
| 21/02    | 500  | 8            | 550      |
| 21/03    | 1000 | 8            | 680      |

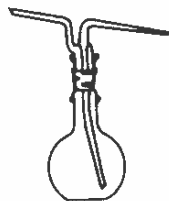

22

**STOPPER ONLY FOR WASH BOTTLES**

| CAT. REF | CAP. | QTY Per CASE | PRICE/PC |
|----------|------|--------------|----------|
| 22/01    | 250  | 8            | 280      |
| 22/02    | 500  | 8            | 350      |
| 22/03    | 1000 | 8            | 370      |

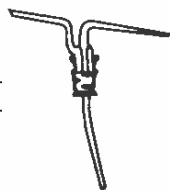

23

**BOTTLE ONLY FOR WASH BOTTLES**

| CAT. REF | CAP. | QTY Per CASE | PRICE/PC |
|----------|------|--------------|----------|
| 23/01    | 250  | 8            | 270      |
| 23/02    | 500  | 8            | 450      |
| 23/03    | 1000 | 8            | 550      |



24

**BOTTLES, GAS WASHING, COMPLETE WITH I/C STOPPER**

| CAT. REF | CAP. | QTY Per CASE | PRICE/PC |
|----------|------|--------------|----------|
| 24/01    | 125  | 8            | 680      |
| 24/02    | 250  | 8            | 750      |
| 24/03    | 500  | 8            | 890      |
| 24/04    | 1000 | 8            | 1250     |

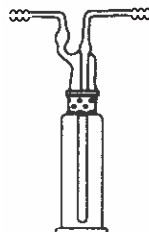



**25  
STOPPER ONLY FOR GAS WASHING BOTTLES**

| CAT. REF | CAP. | QTY Per CASE | PRICE/PC |
|----------|------|--------------|----------|
| 25/01    | 125  | 8            | 250      |
| 25/02    | 250  | 8            | 280      |
| 25/03    | 500  | 8            | 350      |
| 25/04    | 1000 | 8            | 370      |

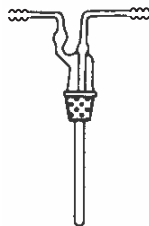

**26  
BOTTLE, ONLY FOR GAS WASHING BOTTLES**

| CAT. REF | CAP. | QTY Per CASE | PRICE/PC |
|----------|------|--------------|----------|
| 26/01    | 125  | 8            | 550      |
| 26/02    | 250  | 8            | 650      |
| 26/03    | 500  | 8            | 700      |
| 26/04    | 1000 | 8            | 950      |



**27  
VACUUM TRAP WITH I/C JOINT OR W/O JOINT**

| CAT. REF | CAP. | LENGTH MM | PRICE/PC |
|----------|------|-----------|----------|
| 27/01    | 18   | 150       | 160      |
| 27/02    | 25   | 150       | 300      |
| 27/03    | 38   | 200       | 320      |
| 27/04    | 55   | 300       | 700      |

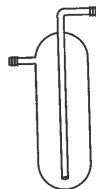

**28  
GAS SAMPLING, TUBES, STRAIGHT BORE STOPCOCK**

| CAT. REF | CAP. | PRICE/PC |
|----------|------|----------|
| 28/01    | 125  | 350      |
| 28/02    | 250  | 450      |
| 28/03    | 500  | 620      |

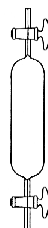

**29  
CARBON DIOXIDE APPARATUS SCHRODTER'S**

| CAT. REF | PRICE/PC |
|----------|----------|
| 29/01    | 1900     |

**SCHRODTER'S / LEIBIG ALKALI METER.**

All Joints Are Interchangeable And The Apparatus Is Small Enough To Be Weighed On The Pan Of Analytical Balance

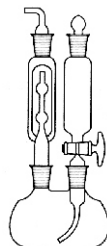



**30**

**BURETTES, PINCH TYPE WITH RUBBER TUBE & METAL CLIP**

| CAT. REF | CAP. | QTY Per CASE | PRICE/PC |
|----------|------|--------------|----------|
| 30/01    | 10   | 8            | 110      |
| 30/02    | 25   | 8            | 125      |
| 30/03    | 50   | 8            | 150      |
| 30/04    | 100  | 8            | 190      |



**31**

**BURETTES, ROTAFLO, STOPCOCKS WITH PTFE KEYS, CLASS B**

| CAT. REF | CAP.    | QTY Per CASE | PRICE/PC |
|----------|---------|--------------|----------|
| 31/01    | 10X0.05 | 4            | 150      |
| 31/02    | 25X0.10 | 4            | 160      |
| 31/03    | 50X0.10 | 4            | 170      |
| 31/04    | 100X0.2 | 4            | 250      |



**32**

**BURETTES, ROTAFLOW, FITTED WITH ROTAFLOW SCREW  
THREAD STOPCOCKS WITH PTFE KEYS, CLASS 'A' WITH WORK  
CERTIFICATE**

| CAT. REF | CAP.    | QTY Per CASE | PRICE/PC |
|----------|---------|--------------|----------|
| 32/01    | 10X0.05 | 4            | 280      |
| 32/02    | 25X0.10 | 4            | 350      |
| 32/03    | 50X0.10 | 4            | 380      |
| 32/04    | 100X0.2 | 4            | 475      |



**33**

**BURETTES, STRAIGHT BORE STOPCOCK, CLASS B**

| CAT. REF | CAP.     | QTY Per CASE | PRICE/PC |
|----------|----------|--------------|----------|
| 33/01    | 1X0.01   | 6            | 180      |
| 33/02    | 2X0.02   | 6            | 190      |
| 33/03    | 5X0.02   | 4            | 210      |
| 33/04    | 10X0.05  | 4            | 220      |
| 33/05    | 25X0.10  | 4            | 230      |
| 33/06    | 50X0.10  | 4            | 250      |
| 33/07    | 100X0.20 | 4            | 265      |



**34****BURETTES, STRAIGHT BORE STOPCOCK, CLASS 'A'  
WITH WORK CERTIFICATE**

| CAT. REF | CAP.     | QTY Per CASE | PRICE/PC |
|----------|----------|--------------|----------|
| 34/01    | 1X0.01   | 6            | 350      |
| 34/02    | 2X0.02   | 6            | 350      |
| 34/03    | 5X0.02   | 4            | 350      |
| 34/04    | 10X0.05  | 4            | 450      |
| 34/05    | 25X0.10  | 4            | 510      |
| 34/06    | 50X0.10  | 4            | 530      |
| 34/07    | 100X0.20 | 4            | 570      |

**35****BURETTES, STRAIGHT BORE PTFE KEY STOPCOCK, CLASS B**

| CAT. REF | CAP. | QTY Per CASE | PRICE/PC |
|----------|------|--------------|----------|
| 35/01    | 25   | 4            | 490      |
| 35/02    | 50   | 4            | 520      |

**36****BURETTES, AUTOMATIC ZERO, MOUNTED ON RESERVOIR  
CLASS B**

| CAT. REF | CAP.    | QTY Per CASE | PRICE/PC |
|----------|---------|--------------|----------|
| 36/01    | 10X0.05 | 2            | 3450     |
| 36/02    | 25X0.1  | 2            | 3950     |
| 36/03    | 50X0.1  | 2            | 4350     |
| 36/04    | 100X0.2 | 2            | 4650     |

Reservoir Capacity :

500 ml. for 10 ml. size and 2000ml. for 25,50,100 ml

**37****BURETTES, AUTOMATIC ZERO, MOUNTED ON RESERVOIR  
CLASS 'A' WITH WORK CERTIFICATE**

| CAT. REF | CAP.    | QTY Per CASE | PRICE/PC |
|----------|---------|--------------|----------|
| 37/01    | 10X0.05 | 2            | 4850     |
| 37/02    | 25X0.1  | 2            | 4980     |
| 37/03    | 50X0.1  | 2            | 5200     |
| 37/04    | 100X0.2 | 2            | 5650     |

Reservoir Capacity :

500 ml. for 10 ml. size and 2000ml. for 25,50 and 10ml. sizes





**38**

**BURETTES, AUTOMATIC ZERO, AMBER Colour, Complete with Reservoir. Class : B**

| CAT. REF | CAP.    | QTY per CASE | PRICE/PC |
|----------|---------|--------------|----------|
| 38/01    | 10X0.05 | 2            | 4850     |
| 38/02    | 25X0.1  | 2            | 5250     |
| 38/03    | 50X0.1  | 2            | 5350     |
| 38/04    | 100X0.2 | 2            | 5780     |

Reservoir Capacity :

500 ml. for 10 ml. size and 2000ml. for 25,50,100 ml



**39**

**BURETTES, AMBER COLOR AUTOMATIC ZERO, MOUNTED ON RESERVOIR CLASS 'A' WITH WORK CERTIFICATE**

| CAT. REF | CAP.    | QTY per CASE | PRICE/PC |
|----------|---------|--------------|----------|
| 39/01    | 10X0.05 | 2            | 5750     |
| 39/02    | 25X0.1  | 2            | 5950     |
| 39/03    | 50X0.1  | 2            | 6500     |
| 39/04    | 100X0.2 | 2            | 6750     |

Reservoir Capacity :

500 ml. for 10 ml. size and 2000ml. for 25,50,100 ml



**40**

**CONDENSER LIEBIG WITH SEALED INNER TUBE**

| CAT. REF | LENGTH MM | QTY per CASE | PRICE/PC |
|----------|-----------|--------------|----------|
| 40/01    | 200       | 6            | 200      |
| 40/02    | 300       | 6            | 250      |
| 40/03    | 400       | 6            | 280      |
| 40/04    | 500       | 6            | 390      |
| 40/05    | 600       | 6            | 480      |



**41**

**LIEBIG CONDENSER WITH I/C JOINT**

| CAT. REF. | Approximate Jacket Length mm | QTY per CASE | PRICE/PC |
|-----------|------------------------------|--------------|----------|
| 41/01     | 150                          | 6            | 220      |
| 41/02     | 200                          | 6            | 250      |
| 41/03     | 300                          | 6            | 305      |
| 41/04     | 400                          | 6            | 340      |
| 41/05     | 500                          | 4            | 390      |
| 41/06     | 600                          | 4            | 750      |
| 41/07     | 750                          | 4            | 900      |





42

**CONDENSER DOUBLE SURFACE (DAVIES)**

| CAT. REF | LENGTH MM | QTY Per CASE | PRICE/PC |
|----------|-----------|--------------|----------|
| 42/01    | 100       | 6            | 410      |
| 42/02    | 150       | 6            | 430      |
| 42/03    | 200       | 6            | 550      |
| 42/04    | 300       | 6            | 670      |
| 42/05    | 400       | 4            | 750      |
| 42/06    | 500       | 4            | 770      |
| 42/07    | 600       | 4            | 990      |



43

**CONDENSER JACKETED COIL**

| CAT. REF | LENGTH MM | QTY Per CASE | PRICE/PC |
|----------|-----------|--------------|----------|
| 43/01    | 150       | 4            | 630      |
| 43/02    | 200       | 4            | 680      |
| 43/03    | 300       | 4            | 700      |
| 43/04    | 400       | 4            | 730      |
| 43/05    | 450       | 4            | 750      |
| 43/06    | 500       | 4            | 910      |
| 43/07    | 600       | 4            | 1150     |
| 43/08    | 700       | 4            | 1550     |
| 43/09    | 750       | 4            | 1950     |



44

**CONDENSERS, GRAHAM, COILED WATER IN COIL, DRIP TIP, L/C INNER JOINT & I/C OUTER JOINT**

| CAT. REF | LENGTH mm | QTY Per CASE | PRICE/PC |
|----------|-----------|--------------|----------|
| 44/01    | 450       | 4            | 370      |
| 44/02    | 550       | 4            | 470      |
| 44/03    | 650       | 4            | 570      |
| 44/04    | 750       | 4            | 730      |



45

**COLUMN FRACTIONATING, VIGREUX**

| CAT. REF | LENGTH mm | QTY Per CASE | PRICE/PC |
|----------|-----------|--------------|----------|
| 45/01    | 200       | 6            | 510      |
| 45/02    | 300       | 6            | 540      |
| 45/03    | 400       | 6            | 760      |
| 45/04    | 600       | 4            | 990      |
| 45/05    | 750       | 4            | 1260     |





46

**CONDENSER. COIL DISTILLATE**

| CAT. REF | LENGTH mm | QTY Per CASE | PRICE/PC |
|----------|-----------|--------------|----------|
| 46/01    | 200       | 6            | 490      |
| 46/02    | 300       | 6            | 550      |
| 46/03    | 400       | 6            | 650      |
| 46/04    | 500       | 4            | 1030     |
| 46/05    | 600       | 4            | 1150     |
| 46/06    | 750       | 4            | 1850     |

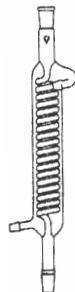

47

**CONDENSER, FREDRICH'S, DRIP TIP, I/C INNER JOINT & I/C OUTER JOINT**

| CAT. REF | APPROX JACKET LENGTH mm | I/C JOINT INNER | I/C JOINT OUTER | PRICE/PC |
|----------|-------------------------|-----------------|-----------------|----------|
| 47/01    | 150                     | B 19            | B 24            | 1150     |
| 47/02    | 350                     | B 24            | B 24            | 1450     |

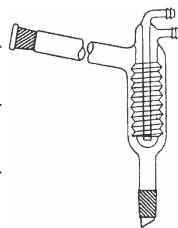

48

**AIR CONDENSER CONE ONLY**

| CAT. REF | LENGTH mm | QTY Per CASE | PRICE/PC |
|----------|-----------|--------------|----------|
| 48/01    | 200       | 6            | 95       |
| 48/02    | 300       | 6            | 120      |
| 48/03    | 400       | 6            | 150      |
| 48/04    | 500       | 4            | 180      |
| 48/05    | 600       | 4            | 195      |
| 48/06    | 1000      | 4            | 325      |



49

**FUNNELS, BUCHNER TYPE, WITH SINTERED DISC, AS PER POROSITY OPTIONS**

| CAT. REF | CAP. | POROSITY GRADE | PRICE/PC |
|----------|------|----------------|----------|
| 49/01    | 35   |                | 250      |
| 49/02    | 80   |                | 450      |
| 49/03    | 100  | G/1            | 580      |
| 49/04    | 200  | TO             | 900      |
| 49/05    | 500  | G/4            | 2200     |
| 49/06    | 1000 |                | 6000     |
| 49/07    | 2000 |                | 13000    |





50

**CHROMATOGRAPHY COLUMN PLAIN, WITH SINTERED DISC, WITH GLASS STOPCOCK OR TEFLON SCREW TYPE STOPCOCK**

| CAT. REF | DIA mm | LENGTH mm | PRICE/PC |
|----------|--------|-----------|----------|
| 50/01    | 10     | 200       | 550      |
| 50/02    | 10     | 300       | 600      |
| 50/03    | 20     | 300       | 720      |
| 50/04    | 20     | 450       | 900      |
| 50/05    | 30     | 450       | 1100     |
| 50/06    | 30     | 500       | 1150     |
| 50/07    | 40     | 600       | 1500     |
| 50/08    | 40     | 750       | 1650     |



51

**CHROMATOGRAPHY COLUMN PLAIN, WITH SINTERED DISC, WITHOUT STOPCOCK**

| CAT. REF | DIA mm | LENGTH mm | PRICE/PC |
|----------|--------|-----------|----------|
| 51/01    | 10     | 200       | 270      |
| 51/02    | 10     | 300       | 290      |
| 51/03    | 20     | 300       | 360      |
| 51/04    | 20     | 450       | 600      |
| 51/05    | 30     | 450       | 620      |
| 51/06    | 40     | 500       | 660      |
| 51/07    | 30     | 600       | 680      |
| 51/08    | 40     | 600       | 725      |
| 51/09    | 40     | 750       | 890      |

\* Please specify sintered disc G -1, 2, 3, 4 required by you.



52

**CHROMATOGRAPHY COLUMN PLAIN WITH GLASS STOPCOCK OR TEFLON SCREW COCK**

| CAT. REF | DIA mm | LENGTH mm | PRICE/PC |
|----------|--------|-----------|----------|
| 52/01    | 10     | 150       | 180      |
| 52/02    | 10     | 200       | 250      |
| 52/03    | 10     | 300       | 280      |
| 52/04    | 20     | 300       | 300      |
| 52/05    | 25     | 300       | 350      |
| 52/06    | 30     | 300       | 400      |
| 52/07    | 20     | 450       | 430      |
| 52/08    | 25     | 450       | 460      |
| 52/09    | 30     | 450       | 500      |
| 52/10    | 50     | 450       | 750      |
| 52/11    | 40     | 1000      | 1050     |





### 53

#### PIPELINE, FILTERS, DOUBLE DRAWN, WITH SINTERED DISC, AS PER POROSITY OPTIONS

| CAT. REF | CAP ml | POROSITY GRADE OPTION | PRICE /PC |
|----------|--------|-----------------------|-----------|
| 53/01    | 30     | G 1 / G 2 / G 3 / G 4 | 300       |
| 53/02    | 30     | G 5                   | 375       |
| 53/03    | 65     | G 1 / G 2 / G 3 / G 4 | 1130      |
| 53/04    | 65     | G 5                   | 1300      |
| 53/05    | 90     | G 1 / G 2 / G 3 / G 4 | 1950      |
| 53/06    | 90     | G 5                   | 2950      |
| 53/07    | 125    | G 1 / G 2 / G 3 / G 4 | 4300      |
| 53/08    | 125    | G 5                   | 5150      |



### 54

#### CYLINDERS, MEASURING WITH ROUND BASE CLASS B

| CAT. REF | CAP  | QTY Per CASE | PRICE/PC |
|----------|------|--------------|----------|
| 54/01    | 5    | 8            | 90       |
| 54/02    | 10   | 8            | 140      |
| 54/03    | 25   | 12           | 180      |
| 54/04    | 50   | 12           | 190      |
| 54/05    | 100  | 12           | 240      |
| 54/06    | 250  | 8            | 390      |
| 54/07    | 500  | 4            | 550      |
| 54/08    | 1000 | 4            | 850      |
| 54/09    | 2000 | 2            | 1600     |

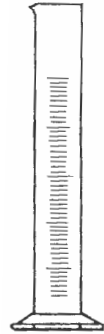

### 55

#### CYLINDERS, MEASURING WITH ROUND BASE CLASS 'A' WITH WORK CERTIFICATE

| CAT. REF | CAP  | QTY Per CASE | PRICE/PC |
|----------|------|--------------|----------|
| 55/01    | 5    | 8            | 240      |
| 55/02    | 10   | 8            | 280      |
| 55/03    | 25   | 12           | 340      |
| 55/04    | 50   | 12           | 390      |
| 55/05    | 100  | 12           | 450      |
| 55/06    | 250  | 8            | 710      |
| 55/07    | 500  | 4            | 950      |
| 55/08    | 1000 | 4            | 1270     |
| 55/09    | 2000 | 2            | 2150     |





56

**CYLINDERS, GRADUATED, SINGLE METRIC SCALE, WITH PENNY HEAD, I/C STOPPER WITH HEXAGONAL BASE**

| CAT. REF | CAP. | QTY Per CASE | PRICE/PC |
|----------|------|--------------|----------|
| 56/01    | 5    | 4            | 210      |
| 56/02    | 10   | 8            | 240      |
| 56/03    | 25   | 12           | 270      |
| 56/04    | 50   | 12           | 310      |
| 56/05    | 100  | 8            | 380      |
| 56/06    | 250  | 4            | 630      |
| 56/07    | 500  | 2            | 880      |
| 56/08    | 1000 | 2            | 1280     |
| 56/09    | 2000 | 2            | 1970     |



57

**CYLINDERS, GRADUATED, SINGLE METRIC SCALE, WITH POUR OUT WITH HEXAGONAL BASE CLASS B**

| CAT. REF | CAP  | QTY Per CASE | PRICE/PC |
|----------|------|--------------|----------|
| 57/01    | 5    | 8            | 145      |
| 57/02    | 10   | 8            | 165      |
| 57/03    | 25   | 12           | 195      |
| 57/04    | 50   | 12           | 220      |
| 57/05    | 100  | 12           | 255      |
| 57/06    | 250  | 8            | 475      |
| 57/07    | 500  | 4            | 620      |
| 57/08    | 1000 | 4            | 940      |
| 57/09    | 2000 | 2            | 1830     |



58

**CYLINDERS, NESSLER, COLOUR COMPARISON, FLAT BOTTOM, GRADUATED**

| CAT. REF | CAP. | QTY Per CASE | PRICE/PC |
|----------|------|--------------|----------|
| 58/01    | 50   | 20           | 110      |
| 58/02    | 100  | 20           | 160      |

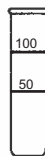

59

**CROW RECEIVER CYLINDER**

| CAT. REF | CAP. | QTY Per CASE | PRICE/PC |
|----------|------|--------------|----------|
| 59/01    | 25   | 20           | 210      |
| 59/02    | 50   | 20           | 230      |
| 59/03    | 100  | 20           | 270      |

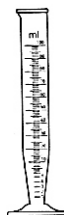



60

**DESICCATORS, WITH COVER, KNOB TOP**

| CAT. REF | SIZE   | QTY Per CASE | PRICE/PC |
|----------|--------|--------------|----------|
| 60/01    | 100 MM | 2            | 4000     |
| 60/02    | 150 MM | 2            | 4300     |
| 60/03    | 200 MM | 2            | 4850     |
| 60/04    | 250 MM | 1            | 6950     |
| 60/05    | 300 MM | 1            | 11850    |
| 60/06    | 400 MM | 1            | 18000    |

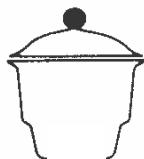

61

**DESICCATORS, VACUUM, WITH TUBULATED COVER, STOPPER WITH PTFE SPINDLE**

| CAT. REF | SIZE   | QTY Per CASE | PRICE/PC |
|----------|--------|--------------|----------|
| 61/01    | 100 MM | 2            | 7400     |
| 61/02    | 200 MM | 2            | 10500    |
| 61/03    | 250 MM | 2            | 18000    |
| 61/04    | 300 MM | 2            | 19500    |



62

**DISHES, CRYSTALLIZING**

| CAT. REF | SIZE      | QTY Per CASE | PRICE/PC |
|----------|-----------|--------------|----------|
| 62/01    | 100X50MM  | 16           | 290      |
| 62/02    | 150X75MM  | 12           | 495      |
| 62/03    | 190X100MM | 2            | 840      |



63

**DISHES, PETRI, CULTURE PLATES**

| CAT. REF | SIZE     | QTY Per CASE | PRICE/PC |
|----------|----------|--------------|----------|
| 63/01    | 60X15MM  | 48           | 120      |
| 63/02    | 75X15MM  | 48           | 150      |
| 63/03    | 90X15MM  | 48           | 170      |
| 63/04    | 100X15MM | 20           | 180      |
| 63/05    | 150X20MM | 8            | 465      |
| 63/06    | 200X20MM | 8            | 1150     |

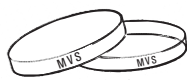



64

**COMPLETE EXTRACTION APPARATUS**

| CAT. REF | CAP  | QTY Per CASE | PRICE/PC |
|----------|------|--------------|----------|
| 64/01    | 60   | 2            | 750      |
| 64/02    | 100  | 2            | 950      |
| 64/03    | 200  | 2            | 1300     |
| 64/04    | 400  | 1            | 2050     |
| 64/05    | 600  | 1            | 2800     |
| 64/06    | 1000 | 1            | 4850     |



65

**EXTRACTORS, ONLY SOXHLET, INTERCHANGEABLE JOINT**

| CAT. REF | SIZE CAP ML | QTY Per CASE | PRICE/PC |
|----------|-------------|--------------|----------|
| 65/01    | 60          | 4            | 360      |
| 65/02    | 100         | 4            | 430      |
| 65/03    | 200         | 4            | 580      |
| 65/04    | 400         | 2            | 950      |



66

**CONDENSER ONLY FOR EXTRACTION APPARATUS, ALLIHN**

| CAT. REF | SIZE CAP ML | QTY Per CASE | PRICE/PC |
|----------|-------------|--------------|----------|
| 66/01    | 60          | 2            | 300      |
| 66/02    | 100         | 2            | 415      |
| 66/03    | 200         | 2            | 480      |
| 66/04    | 400         | 2            | 830      |



67

**ROTARY FLASK (BUCHI TYPE)**

| CAT. REF | CAP   | QTY Per CASE | PRICE/PC |
|----------|-------|--------------|----------|
| 67/01    | 50    | 4            | 300      |
| 67/02    | 100   | 4            | 370      |
| 67/03    | 250   | 4            | 470      |
| 67/04    | 500   | 4            | 510      |
| 67/05    | 1000  | 2            | 780      |
| 67/06    | 2000  | 2            | 1190     |
| 67/07    | 5000  | 2            | 4150     |
| 67/08    | 10000 | 2            | 6510     |





68

**FLASK, FLAT BOTTOM, BOILING, FLORENCE**

| CAT. REF | CAP.  | QTY Per CASE | PRICE/PC |
|----------|-------|--------------|----------|
| 68/01    | 25    | 48           | 62       |
| 68/02    | 50    | 48           | 70       |
| 68/03    | 100   | 48           | 75       |
| 68/04    | 150   | 36           | 85       |
| 68/05    | 250   | 48           | 95       |
| 68/06    | 300   | 24           | 125      |
| 68/07    | 500   | 24           | 140      |
| 68/08    | 1000  | 12           | 220      |
| 68/09    | 2000  | 8            | 395      |
| 68/10    | 3000  | 2            | 1050     |
| 68/11    | 5000  | 4            | 1750     |
| 68/12    | 6000  | 2            | 2800     |
| 68/13    | 10000 | 2            | 3650     |
| 68/14    | 20000 | 2            | 6900     |

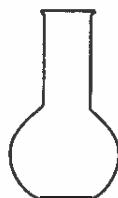

69

**FLASK, ROUND BOTTOM, BOILING**

| CAT. REF | CAP.  | QTY Per CASE | PRICE/PC |
|----------|-------|--------------|----------|
| 69/01    | 25    | 48           | 62       |
| 69/02    | 50    | 48           | 70       |
| 69/03    | 100   | 48           | 75       |
| 69/04    | 150   | 36           | 85       |
| 69/05    | 250   | 48           | 95       |
| 69/06    | 500   | 24           | 140      |
| 69/07    | 1000  | 12           | 220      |
| 69/08    | 2000  | 8            | 395      |
| 69/09    | 3000  | 4            | 1050     |
| 69/10    | 5000  | 4            | 1750     |
| 69/11    | 6000  | 2            | 2800     |
| 69/12    | 10000 | 2            | 3650     |
| 69/13    | 20000 | 2            | 6900     |

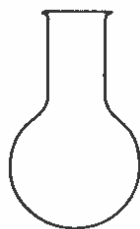

70

**FLASKS, BOILING, PEAR SHAPED, SHORT NECK, WITH I/C JOINT**

| CAT. REF | CAP. | QTY Per CASE | PRICE/PC |
|----------|------|--------------|----------|
| 70/01    | 25   | 12           | 210      |
| 70/02    | 50   | 12           | 240      |
| 70/03    | 100  | 12           | 290      |





71

**FLASKS, ROUND BOTTOM, BOILING, SHORT NECK, WITH I/C JOINT**

| CAT. REF | CAP.  | QTY Per CASE | PRICE/PC |
|----------|-------|--------------|----------|
| 71/01    | 50    | 6            | 102      |
| 71/02    | 100   | 12           | 110      |
| 71/03    | 250   | 12           | 140      |
| 71/04    | 500   | 8            | 200      |
| 71/05    | 1000  | 8            | 280      |
| 71/06    | 2000  | 2            | 540      |
| 71/07    | 3000  | 2            | 1380     |
| 71/08    | 5000  | 2            | 1950     |
| 71/09    | 10000 | 2            | 4500     |
| 71/10    | 20000 | 2            | 8010     |



72

**FLASKS, FLAT BOTTOM, BOILING, SHORT NECK, I / C JOINT**

| CAT. REF | CAP   | QTY Per CASE | PRICE/PC |
|----------|-------|--------------|----------|
| 72/01    | 50    | 6            | 102      |
| 72/02    | 100   | 6            | 110      |
| 72/03    | 250   | 6            | 140      |
| 72/04    | 500   | 6            | 200      |
| 72/05    | 1000  | 6            | 280      |
| 72/06    | 2000  | 6            | 540      |
| 72/07    | 5000  | 6            | 1950     |
| 72/08    | 10000 | 6            | 4500     |
| 72/09    | 20000 | 6            | 8010     |



73

**FLASKS, DISTILLING, WITH SIDE ARM**

| CAT. REF | CAP. | QTY Per CASE | PRICE/PC |
|----------|------|--------------|----------|
| 73/01    | 100  | 12           | 150      |
| 73/02    | 125  | 20           | 165      |
| 73/03    | 250  | 20           | 185      |
| 73/04    | 500  | 4            | 250      |
| 73/05    | 1000 | 4            | 330      |
| 73/06    | 2000 | 4            | 550      |

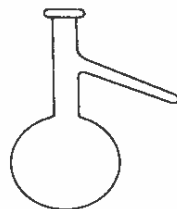



74

**FLASK, TWO NECKS, ROUND BOTTOM, CENTER NECK AND ONE ANGLE NECK WITH INTERCHANGEABLE JOINT**

| CAT. REF | CAP.  | QTY Per CASE | PRICE/PC |
|----------|-------|--------------|----------|
| 74/01    | 100   | 12           | 160      |
| 74/02    | 250   | 12           | 230      |
| 74/03    | 500   | 8            | 340      |
| 74/04    | 1000  | 8            | 410      |
| 74/05    | 2000  | 2            | 740      |
| 74/06    | 3000  | 2            | 1950     |
| 74/07    | 5000  | 2            | 2850     |
| 74/08    | 10000 | 2            | 5400     |
| 74/09    | 20000 | 2            | 8050     |



JOINT SIZES to be indicated while placing orders.

75

**FLASK, TWO NECKS, ROUND BOTTOM, CENTER NECK AND ONE PARALLEL SIDE NECK WITH INTERCHANGEABLE JOINT**

| CAT. REF | CAP.  | QTY Per CASE | PRICE/PC |
|----------|-------|--------------|----------|
| 75/01    | 100   | 12           | 160      |
| 75/02    | 250   | 12           | 230      |
| 75/03    | 500   | 8            | 340      |
| 75/04    | 1000  | 8            | 410      |
| 75/05    | 2000  | 2            | 740      |
| 75/06    | 3000  | 2            | 1950     |
| 75/07    | 5000  | 2            | 2850     |
| 75/08    | 10000 | 2            | 5400     |
| 75/09    | 20000 | 2            | 8050     |

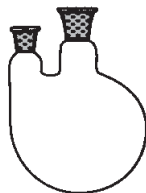

JOINT SIZES to be indicated while placing orders.

76

**FLASK, THREE NECKS, ROUND BOTTOM, CENTER NECK AND TWO ANGLE SIDE NECKS WITH INTERCHANGEABLE JOINT**

| CAT. REF | CAP.  | QTY Per CASE | PRICE/PC |
|----------|-------|--------------|----------|
| 76/01    | 100   | 12           | 220      |
| 76/02    | 250   | 12           | 310      |
| 76/03    | 500   | 8            | 470      |
| 76/04    | 1000  | 8            | 570      |
| 76/05    | 2000  | 2            | 1050     |
| 76/06    | 3000  | 2            | 2550     |
| 76/07    | 5000  | 2            | 3700     |
| 76/08    | 10000 | 2            | 7100     |
| 76/09    | 20000 | 2            | 10500    |



JOINT SIZES to be indicated while placing orders.



77

**FLASK, THREE NECKS, ROUND BOTTOM, CENTER NECK AND TWO PARALLEL SIDE NECKS WITH INTERCHANGEABLE JOINT**

| CAT. REF | CAP.  | QTY Per CASE | PRICE/PC |
|----------|-------|--------------|----------|
| 77/01    | 100   | 12           | 220      |
| 77/02    | 250   | 12           | 310      |
| 77/03    | 500   | 8            | 470      |
| 77/04    | 1000  | 8            | 570      |
| 77/05    | 2000  | 2            | 1050     |
| 77/06    | 3000  | 2            | 2550     |
| 77/07    | 5000  | 2            | 3700     |
| 77/08    | 10000 | 2            | 7100     |
| 77/09    | 20000 | 2            | 10500    |

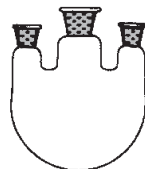

JOINT SIZES to be indicated while placing orders.

78

**FLASK, FOUR NECKS, ROUND BOTTOM, CENTER NECK AND THREE PARALLEL SIDE NECKS,**

| CAT. REF | CAP.  | QTY Per CASE | PRICE/PC |
|----------|-------|--------------|----------|
| 78/01    | 250   | 12           | 510      |
| 78/02    | 500   | 12           | 930      |
| 78/03    | 1000  | 12           | 1070     |
| 78/04    | 2000  | 6            | 1470     |
| 78/05    | 3000  | 6            | 3950     |
| 78/06    | 5000  | 2            | 3910     |
| 78/07    | 10000 | 2            | 7950     |
| 78/08    | 20000 | 1            | 10950    |



79

**FLASK, HAFKINE, CULTURE**

| CAT. REF | CAP. | QTY Per CASE | PRICE/PC |
|----------|------|--------------|----------|
| 79/01    | 3000 | 2            | 1950     |
| 79/02    | 4000 | 2            | 2300     |

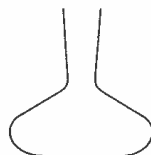



**80**

**FLASKS, KHJELDAHL, ROUND BOTTOM, LONG NECK**

| CAT. REF | CAP. | QTY Per CASE | PRICE/PC |
|----------|------|--------------|----------|
| 80/01    | 10   | 12           | 58       |
| 80/02    | 30   | 8            | 72       |
| 80/03    | 100  | 12           | 125      |
| 80/04    | 300  | 12           | 210      |
| 80/05    | 500  | 8            | 425      |
| 80/06    | 800  | 8            | 510      |



**81**

**FLASKS, KHJELDAHL, ROUND BOTTOM, INTERCHANGEABLE JOINT**

| CAT. REF | CAP. | QTY Per CASE | PRICE/PC |
|----------|------|--------------|----------|
| 81/01    | 300  | 8            | 470      |
| 81/02    | 500  | 8            | 520      |
| 81/03    | 800  | 8            | 590      |



**82**

**BOTTOM ONLY FOR KETTLES**

| CAT. REF | CAP.  | QTY Per CASE | PRICE/PC |
|----------|-------|--------------|----------|
| 82/01    | 500   | 2            | 2800     |
| 82/02    | 1000  | 2            | 3600     |
| 82/03    | 2000  | 2            | 4600     |
| 82/04    | 4000  | 2            | 6100     |
| 82/05    | 5000  | 2            | 7350     |
| 82/06    | 10000 | 2            | 9500     |

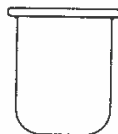

**83**

**COVERS ONLY FOR KETTLES**

| CAT. REF | CAP. | QTY Per CASE | PRICE/PC |
|----------|------|--------------|----------|
| 83/01    | 500  | 2            | 2500     |
| 83/02    | 1000 | 2            | 2700     |
| 83/03    | 2000 | 2            | 3000     |
| 83/04    | 4000 | 2            | 3200     |





84

**VESSEL REACTION, WIDE MOUTH, FLAT FLANGE**

| CAT. REF | CAP   | QTY Per CASE | PRICE/PC |
|----------|-------|--------------|----------|
| 84/01    | 1000  | 2            | 980      |
| 84/02    | 2000  | 2            | 1350     |
| 84/03    | 5000  | 2            | 3140     |
| 84/04    | 10000 | 2            | 6400     |
| 84/05    | 20000 | 2            | 10800    |

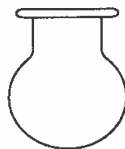

85

**LIDS FOR REACTION FLASKS FLAT FLANGE AND I / C JOINT**

| CAT. REF | CAP                 | QTY Per CASE | PRICE/PC |
|----------|---------------------|--------------|----------|
| 85/01    | 19X26X3,24/29       | 2            | 1850     |
| 85/02    | 19/26,14/23X3,29/32 | 2            | 2250     |
| 85/03    | 29/32/2,14/23/3     | 2            | 2250     |
| 85/04    | 19/26X4,34/35       | 2            | 2250     |
| 85/05    | 1926X3,24/29,34/35  | 2            | 2250     |



86

**KETTLES, RESIN REACTION**

| CAT. REF | CAP.  | QTY Per CASE | PRICE/PC |
|----------|-------|--------------|----------|
| 86/01    | 500   | 2            | 5450     |
| 86/02    | 1000  | 2            | 5550     |
| 86/03    | 2000  | 2            | 7800     |
| 86/04    | 4000  | 2            | 9500     |
| 86/05    | 5000  | 2            | 10800    |
| 86/06    | 10000 | 2            | 12800    |



87

**JACKETTED REACTION KETTLES**

| CAT. REF | CAP.     | QTY Per CASE | PRICE/PC |
|----------|----------|--------------|----------|
| 87/01    | 1000 ml. | 2            | 6500     |
| 87/02    | 2000 ml. | 2            | 7800     |
| 87/03    | 3000 ml. | 2            | 9500     |

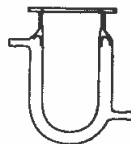



88

**FLAT FLANGE JOINT CLIP**

| CAT. REF | PRICE/PC |
|----------|----------|
| 88/01    | 450      |

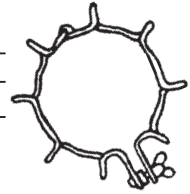

89

**MUSEUM JARS**

| CAT. REF | SIZE    | QTY Per CASE | PRICE/PC |
|----------|---------|--------------|----------|
| 89/01    | 80X200  | 4            | 850      |
| 89/02    | 80X250  | 4            | 1020     |
| 89/03    | 100X200 | 4            | 1020     |
| 89/04    | 100X250 | 4            | 1300     |
| 89/05    | 100X300 | 4            | 1590     |
| 89/06    | 150X200 | 2            | 1590     |
| 89/07    | 150X250 | 2            | 1990     |
| 89/08    | 150X300 | 2            | 2400     |
| 89/09    | 225X250 | 2            | 3000     |
| 89/10    | 225X300 | 2            | 3535     |
| 89/11    | 225X375 | 2            | 4500     |
| 89/12    | 300X300 | 2            | 4800     |
| 89/13    | 300X375 | 2            | 6000     |
| 89/14    | 300X450 | 2            | 7000     |



90

**JARS, BELL, ROUND BOTTOM, EDGE GROUND**

| CAT. REF | SIZE mm | QTY Per CASE | PRICE/PC |
|----------|---------|--------------|----------|
| 90/01    | 300X450 | 2            | 8900     |
| 90/02    | 300X400 | 2            | 8590     |
| 90/03    | 200X350 | 2            | 4300     |

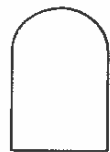

91

**JARS, CYLINDRICAL, FERMENTATION**

| CAT. REF | SIZE mm | QTY Per CASE | PRICE/PC |
|----------|---------|--------------|----------|
| 91/01    | 200X320 | 2            | 5100     |
| 91/02    | 220X455 | 2            | 6710     |
| 91/03    | 315X450 | 1            | 12000    |

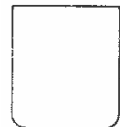



92

**FLASKS, CONICAL ERLLENMEYER, GRADUATED, NARROW MOUTH**

| CAT. REF | CAP.  | QTY Per CASE | PRICE/PC |
|----------|-------|--------------|----------|
| 92/01    | 10    | 24           | 50       |
| 92/02    | 25    | 48           | 52       |
| 92/03    | 50    | 48           | 54       |
| 92/04    | 100   | 48           | 56       |
| 92/05    | 150   | 36           | 72       |
| 92/06    | 250   | 48           | 82       |
| 92/07    | 500   | 24           | 116      |
| 92/08    | 1000  | 12           | 206      |
| 92/09    | 2000  | 8            | 350      |
| 92/10    | 3000  | 2            | 1020     |
| 92/11    | 5000  | 4            | 1650     |
| 92/12    | 10000 | 2            | 2300     |

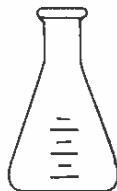

93

**FLASKS, CONICAL, ERLLENMEYER, GRADUATED, AMBER WITH NARROW MOUTH**

| CAT. REF | CAP.  | QTY Per CASE | PRICE/PC |
|----------|-------|--------------|----------|
| 93/01    | 100   | 48           | 110      |
| 93/02    | 150   | 36           | 130      |
| 93/03    | 250   | 48           | 148      |
| 93/04    | 500   | 24           | 220      |
| 93/05    | 1000  | 12           | 430      |
| 93/06    | 2000  | 12           | 580      |
| 93/07    | 3000  | 8            | 840      |
| 93/08    | 5000  | 4            | 1850     |
| 93/09    | 10000 | 2            | 3590     |

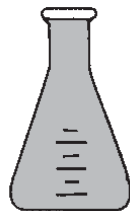

94

**FLASKS, CONICAL, ERLLENMEYER, WIDE MOUTH**

| CAT. REF | CAP. | QTY Per CASE | PRICE/PC |
|----------|------|--------------|----------|
| 94/01    | 100  | 12           | 60       |
| 94/02    | 250  | 12           | 92       |
| 94/03    | 500  | 12           | 145      |
| 94/04    | 1000 | 12           | 260      |
| 94/05    | 2000 | 12           | 390      |
| 94/06    | 5000 | 6            | 850      |

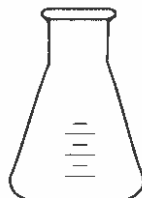



95

**FLASKS, CONICAL, ERLLENMEYER, NARROW MOUTH, WITH I / C STOPPER**

| CAT. REF | CAP. | QTY Per CASE | PRICE/PC |
|----------|------|--------------|----------|
| 95/01    | 25   | 12           | 108      |
| 95/02    | 50   | 12           | 118      |
| 95/03    | 100  | 12           | 140      |
| 95/04    | 250  | 12           | 176      |
| 95/05    | 500  | 12           | 290      |
| 95/06    | 1000 | 12           | 380      |
| 95/07    | 2000 | 8            | 730      |

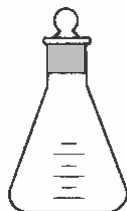

96

**FLASKS, CONICAL B 24, AUTOMATIC TILT MEASURE (SAMPLER) WITH I/C RESERVIOR**

| CAT. REF | CAP. | RESERVIOR CAPACITY ml. | PRICE/PC |
|----------|------|------------------------|----------|
| 96/01    | 1    | 250                    | 250      |
| 96/02    | 2    | 250                    | 250      |
| 96/03    | 3    | 250                    | 250      |
| 96/04    | 5    | 250                    | 316      |
| 96/05    | 10   | 250                    | 320      |
| 96/06    | 15   | 500                    | 430      |
| 96/07    | 20   | 500                    | 440      |
| 96/08    | 25   | 500                    | 580      |

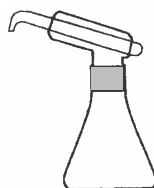

97

**BOTTLE, RELATIVE DENSITY, WITH GLASS CAPILLARY**

| CAT. REF | CAP. | QTY Per CASE | PRICE/PC |
|----------|------|--------------|----------|
| 97/01    | 10   | 12           | 90       |
| 97/02    | 25   | 12           | 104      |
| 97/03    | 50   | 12           | 120      |

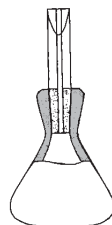

98

**BOTTLE, SPECIFIC GRAVITY WITH THERMOMETER**

| CAT. REF | CAP. | QTY Per CASE | PRICE/PC |
|----------|------|--------------|----------|
| 98/01    | 10   | 12           | 350      |
| 98/02    | 25   | 12           | 370      |
| 98/03    | 50   | 12           | 390      |





99

**FLASKS, FILTERING HEAVY WALL, BOLT NECK WITH TUBULATION**

| CAT. REF | CAP.   | QTY Per CASE | PRICE/PC |
|----------|--------|--------------|----------|
| 99/01    | 50     | 16           | 130      |
| 99/02    | 100    | 16           | 205      |
| 99/03    | 250    | 16           | 285      |
| 99/04    | 500    | 12           | 350      |
| 99/05    | 1000   | 8            | 530      |
| 99/06    | 2000   | 4            | 1050     |
| 99/07    | 5000   | 2            | 4150     |
| 99/08    | 10000* | 2            | 7200     |
| 99/09    | 20000* | 2            | 9980     |

\* These flasks are bottle shaped.



100

**FLASKS, IODINE DETERMINATION, INTERCHANGEABLE STOPPER**

| CAT. REF | CAP. | QTY Per CASE | PRICE/PC |
|----------|------|--------------|----------|
| 100/01   | 100  | 8            | 140      |
| 100/02   | 250  | 8            | 176      |
| 100/03   | 500  | 8            | 210      |

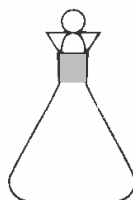

101

**VOLUMETRIC FLASKS, WITH INTERCHANGEABLE STOPPER CLASS B**

| CAT. REF | CAP. | QTY Per CASE | PRICE/PC |
|----------|------|--------------|----------|
| 101/01   | 1    | 8            | 65       |
| 101/02   | 2    | 8            | 65       |
| 101/03   | 5    | 8            | 75       |
| 101/04   | 10   | 8            | 75       |
| 101/05   | 25   | 8            | 105      |
| 101/06   | 50   | 8            | 130      |
| 101/07   | 100  | 8            | 165      |
| 101/08   | 200  | 16           | 178      |
| 101/09   | 250  | 16           | 198      |
| 101/10   | 500  | 16           | 304      |
| 101/11   | 1000 | 8            | 450      |
| 101/12   | 2000 | 4            | 890      |

\* 1 ml. and 2 ml. sizes are of test tube shape.

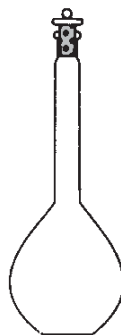



## 102

### VOLUMETRIC FLASK, AMBER COLOUR WITH I/C STOPPER

| CAT. REF | CAP. | QTY Per CASE | PRICE/PC |
|----------|------|--------------|----------|
| 102/01   | 25   | 12           | 220      |
| 102/02   | 50   | 12           | 240      |
| 102/03   | 100  | 12           | 280      |
| 102/04   | 250  | 12           | 320      |
| 102/05   | 500  | 12           | 424      |
| 102/06   | 1000 | 12           | 660      |
| 102/07   | 2000 | 4            | 1150     |

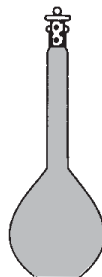

## 103

### VOLUMETRIC FLASKS, WITH INTERCHANGEABLE STOPPER CLASS 'A' WITH WORK CERTIFICATE

| CAT. REF | CAP. | QTY Per CASE | PRICE/PC |
|----------|------|--------------|----------|
| 103/01   | 1    | 8            | 220      |
| 103/02   | 2    | 8            | 220      |
| 103/03   | 5    | 8            | 220      |
| 103/04   | 10   | 8            | 250      |
| 103/05   | 25   | 8            | 256      |
| 103/06   | 50   | 8            | 280      |
| 103/07   | 100  | 8            | 340      |
| 103/08   | 200  | 16           | 410      |
| 103/09   | 250  | 16           | 450      |
| 103/10   | 500  | 16           | 550      |
| 103/11   | 1000 | 8            | 840      |
| 103/12   | 2000 | 4            | 1280     |

\* 1 ml. and 2 ml. sizes are of test tube shape.

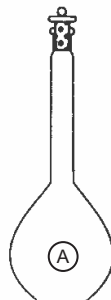

## 104

### VOLUMETRIC FLASK, AMBER COLOUR WITH I/C STOPPER CLASS 'A' WITH WORK CERTIFICATE

| CAT. REF | CAP. | QTY Per CASE | PRICE/PC |
|----------|------|--------------|----------|
| 104/01   | 25   | 12           | 240      |
| 104/02   | 50   | 12           | 246      |
| 104/03   | 100  | 12           | 280      |
| 104/04   | 250  | 12           | 320      |
| 104/05   | 500  | 12           | 470      |
| 104/06   | 1000 | 12           | 730      |
| 104/07   | 2000 | 4            | 1250     |

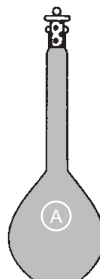



## 105

### FUNNELS, PLAIN, 60 DEGREE ANGLE LONG STEM

| CAT. REF | SIZE MM | QTY Per CASE | PRICE/PC |
|----------|---------|--------------|----------|
| 105/01   | 25      | 12           | 34       |
| 105/02   | 35      | 12           | 40       |
| 105/03   | 50      | 12           | 46       |
| 105/04   | 65      | 12           | 58       |
| 105/05   | 75      | 12           | 62       |
| 105/06   | 100     | 12           | 88       |
| 105/07   | 125     | 12           | 110      |
| 105/08   | 150     | 12           | 140      |

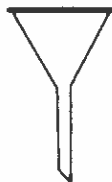

## 106

### FUNNELS, POWDER, SHORT STEM

| CAT. REF | SIZE   | QTY Per CASE | PRICE/PC |
|----------|--------|--------------|----------|
| 106/01   | 100 MM | 30           | 175      |
| 106/02   | 125 MM | 30           | 195      |
| 106/03   | 150 MM | 18           | 240      |
| 106/04   | 200 MM | 4            | 540      |
| 106/05   | 250 MM | 4            | 590      |



## 107

### FUNNELS, POWDER, SHORT STEM WITH CONE

| CAT. REF | CAP.   | QTY Per CASE | PRICE/PC |
|----------|--------|--------------|----------|
| 107/01   | 100 MM | 18           | 195      |
| 107/02   | 125 MM | 4            | 350      |
| 107/03   | 150 MM | 4            | 430      |
| 107/04   | 200 MM | 4            | 920      |

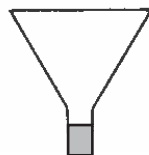

## 108

### FILTER FUNNEL, FUNNEL CUM TEST TUBE WITH HOLE

| CAT. REF | SIZE.    | PRICE/PC |
|----------|----------|----------|
| 108/01   | 15 x 150 | 52       |
| 108/02   | 18 x 150 | 60       |
| 108/03   | 25 x 150 | 65       |

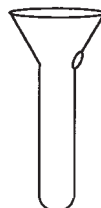



109

**FUNNELS, BUCHNER POECELAIN**

| CAT. REF | DIA mm | QTY Per CASE | PRICE/PC |
|----------|--------|--------------|----------|
| 109/01   | 35     | 12           | 68       |
| 109/02   | 50     | 12           | 84       |
| 109/03   | 60     | 12           | 96       |
| 109/04   | 75     | 12           | 138      |
| 109/05   | 100    | 12           | 176      |
| 109/06   | 125    | 12           | 252      |
| 109/07   | 150    | 6            | 368      |
| 109/08   | 200    | 6            | 856      |
| 109/09   | 250    | 2            | 1764     |
| 109/10   | 300    | 2            | 3280     |
| 109/11   | 400    | 2            | 5420     |



110

**FUNNELS, BUCHNER STAINLESS STEEL**

| CAT. REF | DIA mm | QTY Per CASE | PRICE/PC |
|----------|--------|--------------|----------|
| 110/01   | 150    | 6            | 1710     |
| 110/02   | 200    | 6            | 2270     |
| 110/03   | 250    | 2            | 3740     |
| 110/04   | 300    | 2            | 4850     |



111

**FUNNEL WITH THISTLE HEAD**

| CAT. REF | STEM DIA | LENGTH MM | PRICE/PC |
|----------|----------|-----------|----------|
| 111/01   | 7        | 300       | 50       |



112

**FUNNEL, SEPARATING, GLOBE SHAPE, WITH STOPCOCK AND INTERCHANGEABLE STOPPER**

| CAT. REF | CAP.  | QTY Per CASE | PRICE/PC |
|----------|-------|--------------|----------|
| 112/01   | 125   | 8            | 630      |
| 112/02   | 250   | 8            | 650      |
| 112/03   | 500   | 8            | 830      |
| 112/04   | 1000  | 4            | 1050     |
| 112/05   | 2000  | 4            | 1780     |
| 112/06   | 3000  | 2            | 2640     |
| 112/07   | 5000  | 2            | 3950     |
| 112/08   | 10000 | 1            | 5800     |





113

**FUNNEL, SEPARATING, PEAR SHAPE, WITH GLASS STOPCOCK AND INTERCHANGEABLE STOPPER**

| CAT. REF | CAP. | QTY Per CASE | PRICE/PC |
|----------|------|--------------|----------|
| 113/01   | 60   | 8            | 410      |
| 113/02   | 125  | 8            | 450      |
| 113/03   | 250  | 8            | 495      |
| 113/04   | 500  | 8            | 750      |
| 113/05   | 1000 | 8            | 920      |
| 113/06   | 2000 | 8            | 1650     |
| 113/07   | 3000 | 2            | 2870     |
| 113/08   | 5000 | 2            | 4110     |



114

**FUNNEL, SEPARATING, PEAR SHAPE, WITH HOLLOW PLUG STOPCOCK, HOLLOW INTERCHANGEABLE STOPPER**

| CAT. REF | CAP. | QTY Per CASE | PRICE/PC |
|----------|------|--------------|----------|
| 114/01   | 60   | 8            | 390      |
| 114/02   | 125  | 8            | 460      |
| 114/03   | 250  | 8            | 520      |
| 114/04   | 500  | 8            | 670      |
| 114/05   | 1000 | 8            | 910      |
| 114/06   | 2000 | 4            | 1120     |



115

**FUNNEL, SEPARATING, PEAR SHAPE, FITTED WITH PTFE KEY STOPCOCK WITH INTERCHANGEABLE STOPPER**

| CAT. REF | CAP. | QTY Per CASE | PRICE/PC |
|----------|------|--------------|----------|
| 115/01   | 250  | 8            | 650      |
| 115/02   | 500  | 8            | 820      |
| 115/03   | 1000 | 8            | 1050     |



116

**FILTER PUMP, COLLEGE PATTERN**

| CAT. REF | PRICE/PC |
|----------|----------|
| 116/01   | 150      |





117

**FUNNELS, CYLINDRICAL, GRADUATED WITH CONE SOCKET AND GLASS STOPCOCK**

| CAT. REF | CAP  | QTY Per CASE | PRICE/PC |
|----------|------|--------------|----------|
| 117/01   | 25   | 12           | 250      |
| 117/02   | 50   | 12           | 280      |
| 117/03   | 100  | 12           | 360      |
| 117/04   | 250  | 12           | 510      |
| 117/05   | 500  | 12           | 570      |
| 117/06   | 1000 | 12           | 860      |
| 117/07   | 2000 | 12           | 1450     |



118

**FUNNELS, ADDITION / DROPPING, CYLINDRICAL WITH CONE, OPEN TOP, GLASS OR PTFE KEY, ROTAFLOW**

| CAT. REF | CAP | QTY Per CASE | PRICE/PC |
|----------|-----|--------------|----------|
| 118/01   | 50  | 12           | 220      |
| 118/02   | 100 | 12           | 240      |
| 118/03   | 250 | 12           | 410      |
| 118/04   | 500 | 12           | 540      |

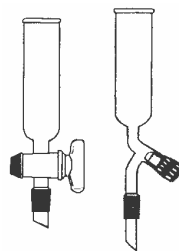

119

**FUNNEL, PRESSURE EQUILIZING, GRADUATED WITH GLASS/PTFE STOPCOCK**

| CAT. REF | CAP. | QTY Per CASE | PRICE/PC |
|----------|------|--------------|----------|
| 119/01   | 25   | 6            | 520      |
| 119/02   | 50   | 6            | 580      |
| 119/03   | 100  | 6            | 650      |
| 119/04   | 250  | 6            | 940      |
| 119/05   | 500  | 6            | 1180     |
| 119/06   | 1000 | 6            | 1510     |
| 119/07   | 2000 | 6            | 2250     |





120

**PIPETTES, MEASURING (MOHR TYPE) CLASS B**

| CAT. REF | CAP.      | QTY Per CASE | PRICE/PC |
|----------|-----------|--------------|----------|
| 120/01   | 0.1X0.01  | 8            | 55       |
| 120/02   | 0.2X0.01  | 8            | 55       |
| 120/03   | 1.0X0.01  | 8            | 55       |
| 120/04   | 1.0X0.10  | 8            | 55       |
| 120/05   | 2.0X0.02  | 8            | 56       |
| 120/06   | 2.0X0.10  | 8            | 56       |
| 120/07   | 5.0X0.05  | 8            | 65       |
| 120/08   | 5.0X0.10  | 8            | 65       |
| 120/09   | 10.0X0.10 | 8            | 80       |
| 120/10   | 25.0X0.20 | 8            | 110      |



121

**PIPETTES, MEASURING (MOHR TYPE) CLASS A  
WITH WORK CERTIFICATE**

| CAT. REF | CAP.      | QTY Per CASE | PRICE/PC |
|----------|-----------|--------------|----------|
| 121/01   | 0.1X0.01  | 8            | 220      |
| 121/02   | 0.2X0.01  | 8            | 220      |
| 121/03   | 1.0X0.01  | 8            | 220      |
| 121/04   | 1.0X0.10  | 8            | 220      |
| 121/05   | 2.0X0.02  | 8            | 220      |
| 121/06   | 2.0X0.10  | 8            | 220      |
| 121/07   | 5.0X0.05  | 8            | 270      |
| 121/08   | 5.0X0.10  | 8            | 270      |
| 121/09   | 10.0X0.10 | 8            | 290      |
| 121/10   | 25.0X0.20 | 8            | 330      |



122

**PIPETTES, SEROLOGICAL CLASS B**

| CAT. REF | CAP.      | QTY Per CASE | PRICE/PC |
|----------|-----------|--------------|----------|
| 122/01   | 0.1X0.01  | 8            | 55       |
| 122/02   | 0.2X0.01  | 8            | 55       |
| 122/03   | 1.0X0.01  | 8            | 55       |
| 122/04   | 1.0X0.10  | 8            | 55       |
| 122/05   | 2.0X0.02  | 8            | 56       |
| 122/06   | 2.0X0.10  | 8            | 56       |
| 122/07   | 5.0X0.05  | 8            | 65       |
| 122/08   | 5.0X0.10  | 8            | 65       |
| 122/09   | 10.0X0.10 | 8            | 80       |
| 122/10   | 25.0X0.20 | 8            | 110      |



**123****PIPETTES, VOLUMETRIC, TRANSFER. CLASS B**

| CAT. REF | CAP. | QTY Per CASE | PRICE/PC |
|----------|------|--------------|----------|
| 123/01   | 1    | 8            | 52       |
| 123/02   | 2    | 8            | 52       |
| 123/03   | 5    | 8            | 58       |
| 123/04   | 10   | 8            | 64       |
| 123/05   | 20   | 8            | 90       |
| 123/06   | 25   | 8            | 90       |
| 123/07   | 50   | 8            | 110      |
| 123/08   | 100  | 8            | 160      |

**124****PIPETTES, VOLUMETRIC, TRANSFER. CLASS A WITH WORK CERTIFICATE**

| CAT. REF | CAP. | QTY Per CASE | PRICE/PC |
|----------|------|--------------|----------|
| 124/01   | 1    | 8            | 150      |
| 124/02   | 2    | 8            | 150      |
| 124/03   | 5    | 8            | 160      |
| 124/04   | 10   | 8            | 190      |
| 124/05   | 25   | 8            | 210      |
| 124/06   | 50   | 8            | 250      |
| 124/07   | 100  | 8            | 350      |

**125****PASTEUR OR TRANSFER PIPETTES**

| CAT. REF | OD x LENGTH MM | QTY | PRICE/PC |
|----------|----------------|-----|----------|
| 125/01   | 7 x 100        | 6   | 20       |
| 125/02   | 7 x 150        | 6   | 25       |
| 125/03   | 7 x 200        | 6   | 30       |

**126****PIPETTES DROPPING**

| CAT. REF | CAP | QTY | PRICE/PC |
|----------|-----|-----|----------|
| 126/01   | 3ml | 12  | 15       |





**127  
DRUM PIPETTE**

| CAT. REF | DRUM SIZE IN Ltr. | QTY Per CASE | PRICE/PC |
|----------|-------------------|--------------|----------|
| 127/01   | 50                | 2            | 250      |
| 127/02   | 100               | 2            | 290      |
| 127/03   | 200               | 2            | 380      |
| 127/04   | 500               | 2            | 700      |



**128  
SILICA CRUCIBLES LOW FORM (Translucent, Indian make)**

| CAT. REF | CAP | QTY Per CASE | PRICE/PC |
|----------|-----|--------------|----------|
| 128/01   | 15  | 12           | 290      |
| 128/02   | 25  | 12           | 350      |
| 128/03   | 50  | 12           | 580      |
| 128/04   | 80  | 12           | 1030     |
| 128/05   | 100 | 12           | 1190     |
| 128/06   | 150 | 12           | 1550     |

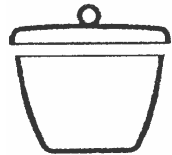

**129  
GOOCH CRUCIBLE, LOW FORM, WITH SINTERED DISC**

| CAT. REF | CAP. | POROSITY GRADE OPTION | PRICE/PC |
|----------|------|-----------------------|----------|
| 129/01   | 15   | G 1 / G 2 / G 3 / G 4 | 140      |
| 129/02   | 30   | G 1 / G 2 / G 3 / G 4 | 190      |
| 129/03   | 30   | G 5                   | 250      |
| 129/04   | 50   | G 1 / G 2 / G 3 / G 4 | 220      |
| 129/05   | 50   | G / 5                 | 265      |

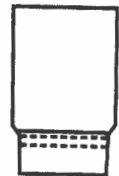

**130  
CRUCIBLE WITH LID, PORCELAIN**

| CAT. REF | CAP. | PRICE /PC |
|----------|------|-----------|
| 130/01   | 10   | 38        |
| 130/02   | 25   | 44        |
| 130/03   | 50   | 86        |
| 130/04   | 80   | 100       |
| 130/05   | 100  | 140       |
| 130/06   | 200  | 250       |

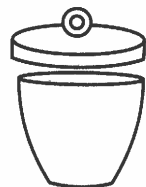



### 131

#### ADAPTER RECEIVER BENDS WITH VACUUM CONNECTION SOCKET TO CONE

| CAT. REF | SOCKET | CONE | PRICE/PC |
|----------|--------|------|----------|
| 131/01   | B14    | B14  | 180      |
| 131/02   | B14    | B19  | 190      |
| 131/03   | B19    | B19  | 200      |
| 131/04   | B19    | B24  | 210      |
| 131/05   | B24    | B19  | 240      |
| 131/06   | B24    | B24  | 250      |
| 131/07   | B29    | B29  | 260      |
| 131/08   | B29    | B34  | 280      |
| 131/09   | B34    | B24  | 300      |
| 131/10   | B34    | B34  | 350      |
| 131/11   | B34    | B55  | 370      |

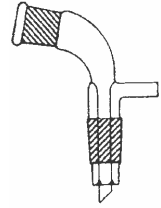

### 132

#### ADAPTER RECEIVER BENDS WITH VENT, SOCKET TO CONE

| CAT. REF | SOCKET | CONE | PRICE/PC |
|----------|--------|------|----------|
| 132/01   | B10    | B10  | 160      |
| 132/02   | B14    | B14  | 190      |
| 132/03   | B14    | B19  | 200      |
| 132/04   | B19    | B14  | 230      |
| 132/05   | B19    | B19  | 250      |
| 132/06   | B19    | B24  | 280      |
| 132/07   | B24    | B19  | 300      |
| 132/08   | B24    | B24  | 330      |
| 132/09   | B29    | B29  | 350      |
| 132/10   | B34    | B34  | 400      |

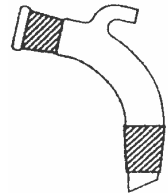

### 133

#### ADAPTER RECEIVER, PLAIN BEND, SHORT

| CAT. REF | SOCKET | CONE | PRICE/PC |
|----------|--------|------|----------|
| 133/01   | B10    |      | 64       |
| 133/02   | B14    |      | 70       |
| 133/03   | B19    |      | 76       |
| 133/04   | B24    |      | 88       |
| 133/05   | B29    |      | 126      |
| 133/06   | B24    |      | 140      |
| 133/07   | B55    |      | 228      |

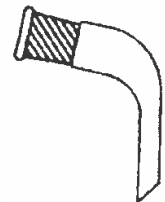



134

**ADAPTER CONE, RIGHT ANGLE CONNECTION**

| CAT. REF | SOCKET | PRICE/PC |
|----------|--------|----------|
| 134/01   | B10    | 70       |
| 134/02   | B14    | 80       |
| 134/03   | B19    | 86       |
| 134/04   | B24    | 90       |
| 134/05   | B29    | 110      |
| 134/06   | B34    | 130      |

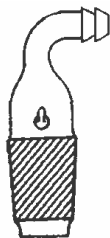

135

**CALCIUM CHLORIDE, DRYING TUBE / GUARD TUBE**

| CAT. REF | CONE | PRICE/PC |
|----------|------|----------|
| 135/01   | B10  | 70       |
| 135/02   | B14  | 76       |
| 135/03   | B19  | 94       |
| 135/04   | B24  | 104      |
| 135/05   | B29  | 140      |
| 135/06   | B34  | 176      |
| 135/07   | B55  | 340      |

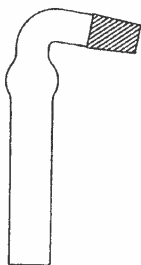

136

**SPLASH HEAD, PEAR SHAPE, SLOPPING**

| CAT. REF | CONE for Flask | CONE for Condenser | PRICE/PC |
|----------|----------------|--------------------|----------|
| 136/01   | B19            | B19                | 190      |
| 136/02   | B24            | B19                | 220      |
| 136/03   | B24            | B24                | 230      |
| 136/04   | B29            | B29                | 290      |
| 136/05   | B34            | B19                | 330      |
| 136/06   | B34            | B24                | 340      |
| 136/07   | B34            | B29                | 370      |
| 136/08   | B34            | B34                | 396      |

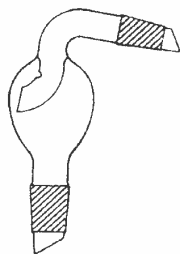

137

**ADAPTER RECEIVER, STRAIGHT DELIVERY**

| CAT. REF | SOCKET | PRICE/PC |
|----------|--------|----------|
| 137/01   | B10    | 62       |
| 137/02   | B14    | 70       |
| 137/03   | B19    | 80       |
| 137/04   | B24    | 92       |
| 137/05   | B29    | 124      |
| 137/06   | B34    | 164      |
| 137/07   | B55    | 230      |





138

**ADAPTER RECEIVER BENDS WITH MULTIPLE CONNECTION  
(PIG) SOCKET TO CONE**

| CAT. REF | SOCKET | CONE | PRICE/PC |
|----------|--------|------|----------|
| 138/01   | B10    | B10  | 510      |
| 138/02   | B14    | B14  | 560      |
| 138/03   | B14    | B19  | 610      |
| 138/04   | B24    | B19  | 630      |
| 138/05   | B24    | B24  | 650      |



139

**STILL HEAD PLAIN, SLOPPING WITH THERMOMETER SOCKET**

| CAT. REF | SOCKET | for Flask | for Condenser | PRICE/PC |
|----------|--------|-----------|---------------|----------|
| 139/01   | B19    | B19       | B19           | 170      |
| 139/02   | B29    | B19       | B19           | 208      |
| 139/03   | B24    | B24       | B19           | 208      |
| 139/04   | B24    | B24       | B24           | 210      |
| 139/05   | B29    | B24       | B19           | 220      |
| 139/06   | B34    | B24       | B19           | 310      |
| 139/07   | B34    | B34       | B19           | 460      |
| 139/08   | B34    | B34       | B24           | 480      |
| 139/09   | B55    | B24       | B19           | 498      |
| 139/10   | B55    | B34       | B19           | 530      |
| 139/11   | B55    | B34       | B24           | 540      |
| 139/12   | B55    | B34       | B34           | 650      |

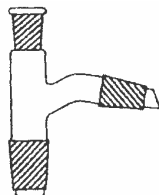

140

**STILL HEAD, PEAR SHAPE, SLOPPING**

| CAT. REF | CONE for flask | CONE for Condenser | PRICE/PC |
|----------|----------------|--------------------|----------|
| 140/01   | B14            | B14                | 170      |
| 140/02   | B19            | B14                | 180      |
| 140/03   | B19            | B19                | 190      |
| 140/04   | B24            | B14                | 200      |
| 140/05   | B24            | B19                | 240      |
| 140/06   | B24            | B24                | 250      |
| 140/07   | B34            | B24                | 260      |
| 140/08   | B34            | B34                | 480      |

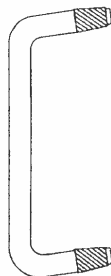



## 141

### MULTIPLE ADAPTER WITH THREE NECK, TWO PARALLEL AND ONE AT ANGLE

| CAT. REF | SOCKET | CONE | PRICE/PC |
|----------|--------|------|----------|
| 141/01   | B14    | B14  | 230      |
| 141/02   | B14    | B19  | 250      |
| 141/03   | B14    | B24  | 280      |
| 141/04   | B19    | B24  | 280      |
| 141/05   | B24    | B24  | 250      |
| 141/06   | B19    | B29  | 305      |
| 141/07   | B24    | B29  | 320      |
| 141/08   | B29    | B29  | 370      |
| 141/09   | B19    | B34  | 398      |
| 141/10   | B24    | B34  | 415      |
| 141/11   | B29    | B34  | 430      |
| 141/12   | B34    | B34  | 460      |
| 141/13   | B19    | B40  | 510      |
| 141/14   | B24    | B40  | 528      |
| 141/15   | B29    | B40  | 580      |
| 141/16   | B34    | B40  | 490      |
| 141/17   | B19    | B45  | 510      |
| 141/18   | B24    | B45  | 510      |
| 141/19   | B29    | B45  | 510      |
| 141/20   | B34    | B45  | 580      |
| 141/21   | B19    | B50  | 560      |
| 141/22   | B24    | B50  | 580      |
| 141/23   | B29    | B50  | 580      |
| 141/24   | B34    | B50  | 598      |
| 141/25   | B24    | B55  | 640      |
| 141/26   | B29    | B55  | 640      |
| 141/27   | B34    | B55  | 750      |

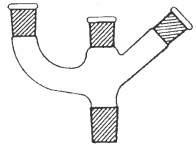

## 142

### STILL HEAD, ADAPTOR RECOVERY BEND, SLOPPING

| CAT. REF | CONE | CONE | PRICE/PC |
|----------|------|------|----------|
| 142/01   | B19  | B19  | 90       |
| 142/02   | B24  | B19  | 114      |
| 142/03   | B24  | B24  | 136      |
| 142/04   | B29  | B29  | 198      |
| 142/05   | B34  | B19  | 204      |
| 142/06   | B34  | B24  | 230      |
| 142/07   | B34  | B29  | 250      |
| 142/08   | B34  | B34  | 280      |

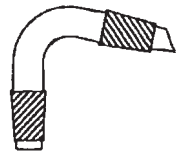



143

**MULTIPLE ADAPTERS WITH TWO PARALLEL NECKS**

| CAT. REF | SOCKET | CONE | PRICE/PC |
|----------|--------|------|----------|
| 143/01   | B10    | B10  | 170      |
| 143/02   | B14    | B14  | 175      |
| 143/03   | B19    | B19  | 190      |
| 143/04   | B19    | B14  | 220      |
| 143/05   | B24    | B19  | 230      |
| 143/06   | B24    | B24  | 240      |
| 143/07   | B29    | B19  | 290      |
| 143/08   | B29    | B24  | 295      |
| 143/09   | B29    | B29  | 310      |
| 143/10   | B34    | B19  | 320      |
| 143/11   | B34    | B24  | 330      |
| 143/12   | B34    | B29  | 340      |
| 143/13   | B34    | B34  | 410      |
| 143/14   | B40    | B24  | 430      |
| 143/15   | B40    | B29  | 520      |
| 143/16   | B40    | B34  | 550      |
| 143/17   | B45    | B24  | 520      |
| 143/18   | B45    | B29  | 550      |
| 143/19   | B45    | B34  | 520      |
| 143/20   | B50    | B24  | 550      |
| 143/21   | B50    | B29  | 560      |
| 143/22   | B50    | B34  | 570      |
| 143/23   | B55    | B19  | 580      |
| 143/24   | B55    | B24  | 598      |
| 143/25   | B55    | B29  | 620      |
| 143/26   | B55    | B34  | 680      |

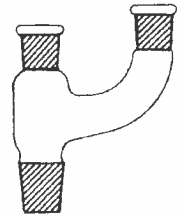

144

**SPARGER, GAS INLET TUBE, AIRLEAK TUBE / STEAM**

| CAT. REF | CONE SIZE | PRICE/PC |
|----------|-----------|----------|
| 144/01   | B10       | 98       |
| 144/02   | B14       | 110      |
| 144/03   | B19       | 120      |
| 144/04   | B24       | 130      |
| 144/05   | B29       | 150      |
| 144/06   | B34       | 220      |

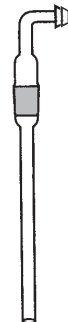



### 145

#### MULTIPLE ADAPTER WITH TWO NECKS, ONE VERTICAL AND OTHER AT AN ANGLE

| CAT. REF | SOCKET | CONE | PRICE/PC |
|----------|--------|------|----------|
| 145/01   | B14    | B14  | 180      |
| 145/02   | B14    | B19  | 190      |
| 145/03   | B19    | B19  | 200      |
| 145/04   | B14    | B24  | 220      |
| 145/05   | B19    | B24  | 240      |
| 145/06   | B24    | B24  | 250      |
| 145/07   | B19    | B29  | 260      |
| 145/08   | B24    | B29  | 270      |
| 145/09   | B29    | B29  | 280      |
| 145/10   | B19    | B34  | 290      |
| 145/11   | B24    | B34  | 320      |
| 145/12   | B29    | B34  | 330      |
| 145/13   | B34    | B34  | 515      |

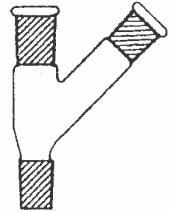

### 146

#### ADAPTERS, ENLARGING, INTERCHANGEABLE JOINTS

| CAT. REF | CAP.   | QTY Per CASE | PRICE/PC |
|----------|--------|--------------|----------|
| 146/01   | B19/14 | 6            | 85       |
| 146/02   | B24/14 | 6            | 98       |
| 146/03   | B24/19 | 6            | 104      |
| 146/04   | B29/19 | 6            | 130      |
| 146/05   | B29/24 | 6            | 140      |
| 146/06   | B34/19 | 6            | 160      |
| 146/07   | B34/24 | 6            | 180      |
| 146/08   | B34/29 | 6            | 200      |



### 147

#### ADAPTERS, REDUCING, INTERCHANGEABLE JOINTS

| CAT. REF | CAP.   | QTY Per CASE | PRICE/PC |
|----------|--------|--------------|----------|
| 147/01   | B14/19 | 6            | 85       |
| 147/02   | B14/24 | 6            | 98       |
| 147/03   | B19/24 | 6            | 110      |
| 147/04   | B19/29 | 6            | 115      |
| 147/05   | B24/29 | 6            | 140      |
| 147/06   | B34/19 | 6            | 140      |
| 147/07   | B24/34 | 6            | 150      |
| 147/08   | B29/34 | 6            | 170      |
| 147/09   | B29/40 | 6            | 210      |

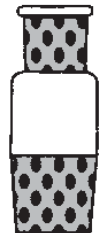



148

**CONE PLAIN AND DOUBLE**

| CAT. REF | CAP.  | QTY Per CASE | PRICE/PC |
|----------|-------|--------------|----------|
| 148/01   | 10/19 | 16           | 80       |
| 148/02   | 14/23 | 16           | 80       |
| 148/03   | 19/26 | 16           | 90       |
| 148/04   | 24/29 | 16           | 105      |
| 148/05   | 29/32 | 16           | 130      |
| 148/06   | 34/35 | 16           | 205      |
| 148/07   | 40/38 | 12           | 280      |
| 148/08   | 55/44 | 12           | 650      |



149

**SOCKET PLAIN AND DOUBLE**

| CAT. REF | CAP.  | QTY Per CASE | PRICE/PC |
|----------|-------|--------------|----------|
| 149/01   | 10/19 | 16           | 80       |
| 149/02   | 14/23 | 16           | 80       |
| 149/03   | 19/26 | 16           | 90       |
| 149/04   | 24/29 | 16           | 105      |
| 149/05   | 29/32 | 16           | 130      |
| 149/06   | 34/35 | 16           | 205      |
| 149/07   | 40/38 | 12           | 280      |
| 149/08   | 55/44 | 12           | 650      |



150

**TUBES CULTURE, MEDIA ROUND BOTTOM WITH SCREW CAP**

| CAT. REF | CAP.           | QTY Per CASE | PRICE/PC |
|----------|----------------|--------------|----------|
| 150/01   | 5 (16x75 mm)   | 275          | 18       |
| 150/02   | 10 (16x125 mm) | 100          | 22       |
| 150/03   | 30 (25x100 mm) | 240          | 32       |
| 150/04   | 60 (25x200 mm) | 100          | 40       |



151

**TUBES CULTURE, MEDIA, FLAT BOTTOM WITH SCREW CAP**

| CAT. REF | CAP.           | QTY Per CASE | PRICE/PC |
|----------|----------------|--------------|----------|
| 151/01   | 5 (16x50 mm)   | 98           | 18       |
| 151/02   | 15 (25x57 mm)  | 98           | 24       |
| 151/03   | 30 (25x95 mm)  | 100          | 32       |
| 151/04   | 40 (25x145 mm) | 100          | 45       |





## 152

### TUBES TEST, WITH RIM

| CAT. REF | SIZE MM | QTY Per CASE | PRICE/PC |
|----------|---------|--------------|----------|
| 152/01   | 10X75   | 400          | 6        |
| 152/02   | 12X75   | 400          | 7        |
| 152/03   | 12X100  | 400          | 8        |
| 152/04   | 15X125  | 400          | 10       |
| 152/05   | 15X150  | 400          | 12       |
| 152/06   | 18X150  | 400          | 13       |
| 152/07   | 25X100  | 400          | 20       |
| 152/08   | 25X150  | 196          | 22       |
| 152/09   | 25X200  | 98           | 30       |
| 152/10   | 32X200  | 72           | 44       |
| 152/11   | 38X200  | 50           | 48       |

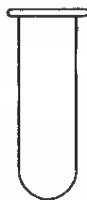

## 153

### TUBES TEST, WITHOUT RIM

| CAT. REF | SIZE MM | QTY Per CASE | PRICE/PC |
|----------|---------|--------------|----------|
| 153/01   | 10X75   | 400          | 6        |
| 153/02   | 12X75   | 400          | 7        |
| 153/03   | 12X100  | 400          | 8        |
| 153/04   | 15X125  | 400          | 10       |
| 153/05   | 15X150  | 400          | 12       |
| 153/06   | 18X150  | 400          | 13       |
| 153/07   | 25X100  | 400          | 20       |
| 153/08   | 25X150  | 196          | 22       |
| 153/09   | 25X200  | 98           | 30       |
| 153/10   | 32X200  | 72           | 44       |
| 153/11   | 38X200  | 50           | 48       |



## 154

### TUBE TEST GRADUATED WITH I/C STOPPER

| CAT. REF | CAP.ML | SIZE MM | PRICE/PC |
|----------|--------|---------|----------|
| 154/01   | 10     | 15X125  | 100      |
| 154/02   | 15     | 18X150  | 110      |
| 154/03   | 25     | 25X150  | 130      |
| 154/04   | 50     | 25X200  | 180      |
| 154/05   | 100    | 38X200  | 240      |





**155**

**TUBE, TEST NATURAL GLASS**

| CAT. REF | SIZE MM | QTY Per CASE | PRICE/PC |
|----------|---------|--------------|----------|
| 155/01   | 10X75   | 400          | 3        |
| 155/02   | 12X75   | 400          | 4        |
| 155/03   | 12X100  | 400          | 5        |
| 155/04   | 15X125  | 400          | 6        |
| 155/05   | 15X150  | 400          | 8        |
| 155/06   | 18X150  | 400          | 9        |
| 155/07   | 25X150  | 400          | 12       |



**156**

**TUBES, CENTRIFUGE, CONICAL BOTTOM GRADUATED**

| CAT. REF | CAP. | QTY Per CASE | PRICE/PC |
|----------|------|--------------|----------|
| 156/01   | 5    | 25           | 34       |
| 156/02   | 10   | 25           | 38       |
| 156/03   | 15   | 25           | 46       |
| 156/04   | 50   | 25           | 94       |



**157**

**TUBES, CENTRIFUGE, CONICAL BOTTOM GRADUATED WITH STOPPER**

| CAT. REF | CAP. | QTY Per CASE | PRICE/PC |
|----------|------|--------------|----------|
| 157/01   | 5    | 25           | 90       |
| 157/02   | 10   | 25           | 90       |
| 157/03   | 15   | 25           | 110      |
| 157/04   | 50   | 25           | 180      |



**158**

**DURHAM TUBES / FERMENTATION TUBES**

| CAT. REF | SIZE MM | QTY | PRICE/PC |
|----------|---------|-----|----------|
| 158/01   | 7X25    | 100 | 360      |
| 158/02   | 7X45    | 100 | 390      |



**159**

**FUSION TUBES / IGNITION TUBES, NEUTRAL GLASS**

| CAT. REF | SIZE MM | QTY | PRICE |
|----------|---------|-----|-------|
| 159/01   | 6.5X50  | 144 | 55    |





**160**  
**STUFFING BOX GLAND, TEFLON (BUSH ONLY)**

| CAT. REF | SIZE    | CONE<br>Size | PRICE/PC |
|----------|---------|--------------|----------|
|          | Dia. mm |              |          |
| 160/01   | 5-7     | B 14         | 310      |
| 160/02   | 6-8     | B 19         | 340      |
| 160/03   | 6-8     | B 24         | 410      |
| 160/04   | 8-10    | B 29         | 570      |
| 160/05   | 8-10    | B 34         | 650      |
| 160/06   | 8-10    | B 45         | 1150     |
| 160/07   | 8-10    | B 55         | 1850     |



**161**  
**STUFFING BOX GLAND WITH PULLEY MADE OF ALL TEFLON**

| CAT. REF | Dia. mm      | CONE | PRICE/PC |
|----------|--------------|------|----------|
| 161/01   | 6 or 8       | B19  | 1250     |
| 161/02   | 6 or 8       | B24  | 1300     |
| 161/03   | 6 or 8 or 10 | B29  | 1350     |
| 161/04   | 6 or 8 or 10 | B34  | 1400     |



**162**  
**GLASS MERCURY SEAL GLAND WITH TEFLON / PTFE, 'O' RING**

| CAT. REF | CONE SIZE | PRICE/PC |
|----------|-----------|----------|
| 162/01   | B 19      | 290      |
| 162/02   | B 24      | 330      |
| 162/03   | B 29      | 300      |
| 162/04   | B 34      | 400      |



**163**  
**STIRRING ROD, BUTTON TYPE**

| CAT. REF | ROD DIA | LENGTH mm | PRICE /PC |
|----------|---------|-----------|-----------|
| 163/01   | 6 mm    | 300       | 50        |
| 163/02   | 7 mm    | 450       | 70        |
| 163/03   | 8 mm    | 450       | 80        |
| 163/04   | 10 mm   | 600       | 90        |
| 163/05   | 12 mm   | 900       | 100       |

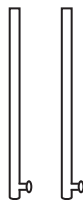



**164**

**TEFLON / PTFE BLADED STIRRER**

| CAT. REF | SHAFT<br>DIA MM | LENGTH<br>MM | TO PASS<br>SOCKET | PRICE /PC |
|----------|-----------------|--------------|-------------------|-----------|
| 164/01   | 6               | 450          | B19               | 170       |
| 164/02   | 6               | 450          | B24               | 180       |
| 164/03   | 8               | 600          | B24               | 250       |
| 164/04   | 8               | 600          | B34               | 270       |
| 164/05   | 10              | 750          | B34               | 350       |
| 164/06   | 10              | 750          | B55               | 590       |

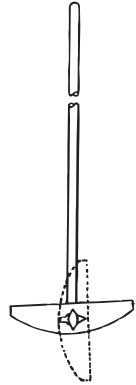

**165**

**TEFLON (PTFE) BLADE TO PASS THROUGH STANDARD I/C JOINT**

| CAT. REF | JOINT SIZE | PRICE /PC |
|----------|------------|-----------|
| 165/01   | B19        | 90        |
| 165/02   | B24        | 110       |
| 165/03   | B29        | 140       |
| 165/04   | B34        | 165       |
| 165/05   | B45        | 310       |
| 165/06   | B55        | 440       |



**166**

**TEFLON / PTFE COATED STIRRING BAR, MAGNETIC ROTORS**

| CAT. REF | APPROX DIA | LENGTH mm | PRICE /PC |
|----------|------------|-----------|-----------|
| 166/01   | 25 X 6     |           | 135       |
| 166/02   | 12 X 6     |           | 115       |
| 166/03   | 19 X 8     |           | 120       |
| 166/04   | 25 X 8     |           | 125       |
| 166/05   | 32 X 8     |           | 135       |
| 166/06   | 38 X 8     |           | 150       |
| 166/07   | 50 X 8     |           | 160       |
| 166/08   | 65 X 8     |           | 200       |
| 166/09   | 22 X 10    |           | 140       |
| 166/10   | 30 X 10    |           | 150       |
| 166/11   | 40 X 10    |           | 160       |
| 166/12   | 50 X 10    |           | 230       |
| 166/13   | 65 X 10    |           | 275       |
| 166/14   | 32 X 13    |           | 275       |
| 166/15   | 38 X 13    |           | 324       |





167

**GLASS RODS WITH ROUND ENDS, 300 MM LONG**

| CAT. REF | DIA mm | PRICE/PC |
|----------|--------|----------|
| 167/01   | 4      | 10       |
| 167/02   | 6      | 14       |
| 167/03   | 7      | 20       |
| 167/04   | 8      | 25       |
| 167/05   | 9      | 32       |
| 167/06   | 10     | 34       |
| 167/07   | 11     | 44       |



168

**THERMOMETER POCKET, SHORT, TIGHT, CLOSED END**

| CAT. REF | SOCKET | PRICE/PC |
|----------|--------|----------|
| 168/01   | B14    | 94       |
| 168/02   | B19    | 114      |
| 168/03   | B24    | 130      |
| 168/04   | B29    | 160      |
| 168/05   | B34    | 190      |



169

**LABORATORY THERMOMETERS**

| CAT. REF | RANGE °C   | QTY Per CASE | PRICE/PC |
|----------|------------|--------------|----------|
| 169/01   | -10 to 50  | 12           | 70       |
| 169/02   | -10 to 110 | 12           | 75       |
| 169/03   | 0 to 150   | 12           | 80       |
| 169/04   | 0 to 250   | 12           | 85       |
| 169/05   | 0 to 360   | 12           | 90       |



170

**MELTING POINT TUBES / CAPILLARY TUBE**

| CAT. REF |                        | PRICE/GROSS |
|----------|------------------------|-------------|
| 170/01   | Neutral Glass          | 60          |
| 170/02   | Corning Glass          | 70          |
| 170/03   | Neutral Glass Big Bore | 60          |





**171**  
**HYDROMETER SPECIFIC GRAVITY, 100 RANGE DIVIDED IN**  
**100 DIVISION**

| CAT. REF | RANGE       | PRICE/PC |
|----------|-------------|----------|
| 171/01   | 600 - 700   | 250      |
| 171/02   | 700 - 800   | 250      |
| 171/03   | 800 - 900   | 250      |
| 171/04   | 900 - 1000  | 250      |
| 171/05   | 1000 - 1100 | 250      |
| 171/06   | 1100 - 1200 | 250      |
| 171/07   | 1200 - 1300 | 250      |
| 171/08   | 1300 - 1400 | 250      |
| 171/09   | 1400 - 1500 | 250      |
| 171/10   | 1500 - 1600 | 250      |
| 171/11   | 1600 - 1700 | 250      |
| 171/12   | 1700 - 1800 | 280      |
| 171/13   | 1800 - 1900 | 280      |
| 171/14   | 1900 - 2000 | 280      |

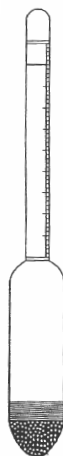

**172**  
**MILLIPORE ASSEMBLY, MEMBRANE, VACUUM FILTER,**  
**(SINTERED ASSEMBLY)**

| CAT. REF | CAP. | DISC DIA mm | PRICE/PC |
|----------|------|-------------|----------|
| 172/01   | 35   | 25          | 2450     |
| 172/02   | 80   | 25          | 2550     |
| 172/03   | 300  | 47          | 4350     |
| 172/04   | 500  | 47          | 7850     |

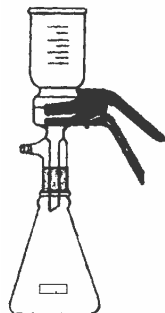

**173**  
**PERKIN'S RECEIVER ADAPTER INTERMEDIATE WITH GLASS**  
**STOPCOCK**

| CAT. REF | SOCKET | CONE | PRICE/PC |
|----------|--------|------|----------|
| 173/01   | B14    | B14  | 1800     |
| 173/02   | B19    | B19  | 2200     |
| 173/03   | B19    | B24  | 2250     |
| 173/04   | B24    | B24  | 2250     |
| 173/05   | B34    | B24  | 2550     |
| 173/06   | B34    | B34  | 2550     |

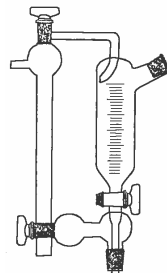



**174**  
**MANOMETER 'U' TUBE CAPILLARY WITH SCALE ON WOODEN BOARD WITHOUT MERCURY**

| CAT. REF | SIZE mm.  | PRICE/PC |
|----------|-----------|----------|
| 174/01   | 120-0-120 | 1250     |
| 174/02   | 250-0-250 | 1550     |
| 174/03   | 500-0-500 | 1850     |
| 174/04   | 0-1000    | 2050     |

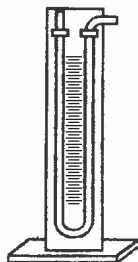

**175**  
**MANOMETER 'U' TUBE CAPILLARY WITHOUT SCALE & MERCURY**

| CAT. REF | SIZE mm. | PRICE/PC |
|----------|----------|----------|
| 175/01   | 250      | 350      |
| 175/02   | 500      | 410      |
| 175/03   | 1000     | 520      |

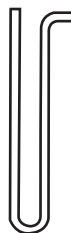

**176**  
**KIPPS APPARATUS, GAS GENERATOR**

| CAT. REF | CAP. | PRICE /PC |
|----------|------|-----------|
| 176/01   | 250  | 2200      |
| 176/02   | 500  | 2700      |
| 176/03   | 1000 | 3200      |

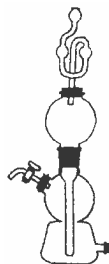

**177**  
**Mc CLEOD GAUGE (Vacustat) COMPLETE WITH STAND**

| CAT. REF | Measuring Range | PRICE |
|----------|-----------------|-------|
| 177/01   | 10 to 0.01      | 8550  |
| 177/02   | 1 to 0.001      | 8550  |

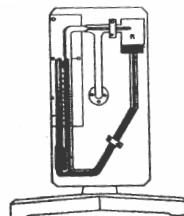



**178**  
**REFLUX DEVIDER HEAD UNIVERSAL**

| CAT. REF | Socket for condenser | Thermometer socket | Cone for column | Spherical ball joints | PRICE/PC |
|----------|----------------------|--------------------|-----------------|-----------------------|----------|
| 178/01   | B19                  | B14                | B19             | S13                   | 800      |
| 178/02   | B24                  | B14                | B24             | S19                   | 900      |
| 178/03   | B34                  | B14                | B34             | S29                   | 1000     |
| 178/04   | B55                  | B19                | B55             | S35                   | 1290     |

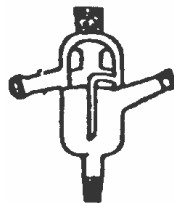

**179**  
**EVAPORATING DISHES, WITH SPOUT**

| CAT. REF | CAP. | OD X Height mm | PRICE / PC |
|----------|------|----------------|------------|
| 179/01   | 90   | 80 x 45        | 300        |
| 179/02   | 170  | 95 x 55        | 410        |
| 179/03   | 600  | 140 x 80       | 590        |



**180**  
**THIELE'S MELTING POINT TUBE**

| CAT. REF | SIZE mm  | PRICE /PC |
|----------|----------|-----------|
| 180/01   | 18 X 125 | 90        |
| 180/02   | 25 X 150 | 120       |



**181**  
**VISCOMETER CANON FENSKS TYPE FOR TRANSPARENT LIQUID**

| CAT. REF | SIZE NO. | Viscosity range CS | PRICE/PC |
|----------|----------|--------------------|----------|
| 181/01   | 100      | 3-12               | 850      |
| 181/02   | 150      | 7-28               | 850      |
| 181/03   | 200      | 20-80              | 850      |
| 181/04   | 300      | 50-200             | 850      |
| 181/05   | 350      | 100-400            | 850      |
| 181/06   | 400      | 240-960            | 900      |
| 181/07   | 450      | 500-2000           | 900      |
| 181/08   | 500      | 1600-6400          | 1150     |
| 181/09   | 600      | 4000-16000         | 1150     |

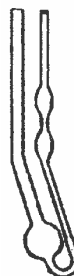



**182**  
**VISCOMETER COLLEGE PATTERN OSTWALD**

| CAT. REF |                   | PRICE/PC |
|----------|-------------------|----------|
| 182/01   | 80 to 100 seconds | 170      |



**183**  
**SYRINGE TYPE STIRRER WITH I/C SHAFT FOR HIGH VACUUM**

| CAT. REF | CAP.  | CONE | PRICE/PC |
|----------|-------|------|----------|
| 183/01   | 500   | B24  | 490      |
| 183/02   | 1000  | B24  | 500      |
| 183/03   | 2000  | B24  | 520      |
| 183/04   | 3000  | B34  | 550      |
| 183/05   | 5000  | B34  | 650      |
| 183/06   | 10000 | B34  | 750      |
| 183/07   | 20000 | B34  | 850      |



**184**  
**SPRAYER FOR CHROMATOGRAPHY WORK**  
**(AUTOMISER SPRAY FOR ANALYSIS)**

| CAT. REF | CAP. | PRICE/PC |
|----------|------|----------|
| 184/01   | 25   | 310      |
| 184/02   | 50   | 320      |
| 184/03   | 100  | 350      |
| 184/04   | 150  | 360      |
| 184/05   | 250  | 380      |



**185**  
**SOLID POWDER ADDITION FUNNEL WITH TEFLON SCREW COCK**

| CAT. REF | CAP     | QTY Per CASE | PRICE/PC |
|----------|---------|--------------|----------|
| 185/01   | 100 ml  | 2            | 2500     |
| 185/02   | 250 ml  | 2            | 3000     |
| 185/03   | 500 ml  | 2            | 3500     |
| 185/04   | 1000 ml | 2            | 4500     |

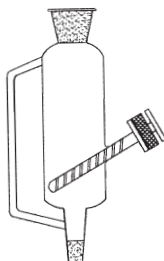



186

**DEAN AND STARK APPARATUS(FOR MOISTURE DETERMINATION)  
LIGHT ENTRAINER WITH STOPCOCK**

| CAT. REF | CAP. OF RECEIVER ML | CAP. | PRICE/PC |
|----------|---------------------|------|----------|
| 186/01   | 2X1/20              | 250  | 1200     |
| 186/02   | 5X1/20              | 500  | 1500     |
| 186/03   | 10X1/10             | 1000 | 2000     |
| 186/04   | 25X1/5              | 1000 | 2500     |
| 186/05   | 50X1/2              | 1000 | 3000     |
| 186/06   | 100X1/1             | 1000 | 3500     |

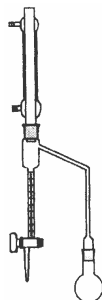

187

**OIL DETERMINATION APPARATUS (CLEVINGER APPARATUS)  
LIGHTER THAN WATER**

| CAT. REF |   |                     |
|----------|---|---------------------|
| 187/01   | Consisting of :                               |                     |
|          | Round Bottom Flask<br>1000 ml. B 24           |                     |
|          | Oil Separatory Tube<br>B 24-19 with Stopcock. |                     |
|          | Leibig Condenser                              | Rs. 3550.00 per set |

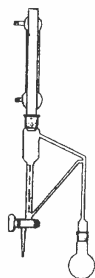

188

**OIL DETERMINATION APPARATUS (CLEVINGER APPARATUS)  
(HEAVIER THAN WATER)**

| CAT. REF |   |                     |
|----------|---|---------------------|
| 188/01   | Consisting of :                               |                     |
|          | Round Bottom Flask<br>1000 ml. B 24           |                     |
|          | Oil Separatory Tube<br>B 24-19 with Stopcock. |                     |
|          | Leibig Condenser                              | Rs. 3550.00 per set |

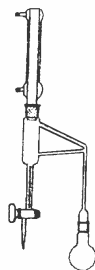

189

**CALCIUM CHLORIDE CYLINDER (TOWER) WITH SIDE TUBES AND  
I/C STOPPER**

| CAT. REF | SIZE mm  | PRICE /PC |
|----------|----------|-----------|
| 189/01   | 250 X 40 | 950       |
| 189/02   | 300 X 45 | 1050      |
| 189/03   | 300 X 50 | 1100      |
| 189/04   | 300 X 60 | 1150      |

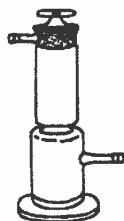



**190  
ROTARY VACUUM EVAPORATOR SYSTEM**

| CAT. REF | CAP     | PRICE on Request |
|----------|---------|------------------|
| 190/01   | 250 ml  | "                |
| 190/02   | 500 ml  | "                |
| 190/03   | 1000 ml | "                |
| 190/04   | 2000 ml | "                |
| 190/05   | 3000 ml | "                |
| 190/06   | 5000 ml | "                |

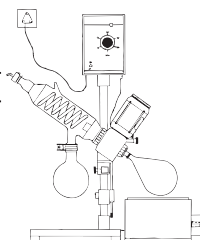

**191  
ROTARY EVAPORATOR INBUILT VACUUM GAUGE SYSTEM WITH  
VERTICAL HEAT EXCHANGER**

| CAT. REF | CAP     | PRICE on Request |
|----------|---------|------------------|
| 191/01   | 250 ml  | "                |
| 191/02   | 500 ml  | "                |
| 191/03   | 1000 ml | "                |
| 191/04   | 2000 ml | "                |
| 191/05   | 3000 ml | "                |
| 191/06   | 5000 ml | "                |

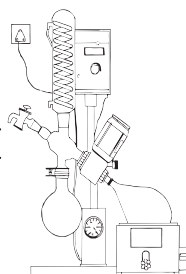

**192  
DISTILLATION APPARATUS  
(BOROSILICATE GLASS WITH S.S. HEATER)**

| CAT. REF | CAP    | QTY Per CASE | PRICE/PC |
|----------|--------|--------------|----------|
| 192/01   | 2 Lit  | 1            | 16500    |
| 192/02   | 5 Lit  | 1            | 18500    |
| 192/03   | 10 Lit | 1            | 22500    |

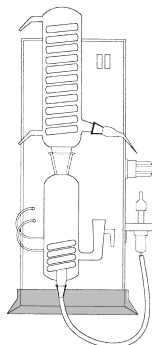



### 193 MICRO KJELDAHL DISTILLATION ASSEMBLY, WITH SPECIAL JOINTS

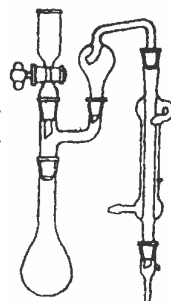

| CAT. REF | Consisting of :                    | PRICE/SET |
|----------|------------------------------------|-----------|
| 193/01   | Kjeldahl flask 800 ml., B 24       |           |
| 193/02   | Multiple adapter, B 24 - 19 - 19   |           |
| 193/03   | Dropping funnel 50 ml., B 19       | Rs. 2500  |
| 193/04   | Receiver adapter B 19              |           |
| 193/05   | Splash head vertical B 19, S 19    |           |
| 193/06   | Leibig condenser 300 mm, B 19 - 19 |           |

### 194 SPECIMEN JARS, RECTANGULAR WITHOUT COVERS

| CAT. REF | L X B X W cm                             | PRICE/PC |
|----------|--|----------|
| 194/01   | 26x15x10                                 | 510      |
| 194/02   | 20x12x10                                 | 450      |
| 194/03   | 22x15x10                                 | 490      |
| 194/04   | 15x15x6                                  | 350      |
| 194/05   | 16x12x10                                 | 350      |
| 194/06   | 20x20x12                                 | 425      |
| 194/07   | 20x20x16                                 | 490      |
| 194/08   | 28x21x10                                 | 1290     |
| 194/09   | 30x15x12                                 | 780      |
| 194/10   | 25x25x12 (Chromatography Tank)           | 1190     |
| 194/11   | Spare lids for specimen jars rectangular | 60       |



### 195 TLC GLASS PLATE

| CAT. REF | SIZE mm   | PRICE/PC |
|----------|-----------|----------|
| 195/01   | 200 X 50  | 40       |
| 195/02   | 200 X 100 | 50       |
| 195/03   | 200 X 200 | 75       |
| 195/04   | 250 X 250 | 100      |

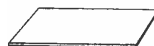

### 196 PYKNO METERS

| CAT. REF | CAP. ML | PRICE/PC |
|----------|---------|----------|
| 196/01   | 5       | 90       |
| 196/02   | 10      | 100      |
| 196/03   | 25      | 150      |
| 196/04   | 50      | 190      |

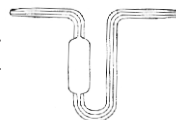



197

**HEATING MANTLE WITH ENERGY REGULATOR AND PILOT LAMPS  
MAXIMUM SURFACE TEMPERATURE UP TO 450°C WITHOUT LOAD**

| CAT. REF | CAP. ML | Rating (Watts) | PRICE/PC |
|----------|---------|----------------|----------|
| 197/01   | 50      | 60             | 2250.00  |
| 197/02   | 100     | 60             | 2450.00  |
| 197/03   | 250     | 150            | 2750.00  |
| 197/04   | 500     | 200            | 2950.00  |
| 197/05   | 1000    | 300            | 3250.00  |
| 197/06   | 2000    | 450            | 3450.00  |
| 197/07   | 3000    | 450            | 3750.00  |
| 197/08   | 5000    | 600            | 4750.00  |
| 197/09   | 10000   | 2 x 500        | 8250.00  |
| 197/10   | 20000   | 3 x 500        | 10050.00 |

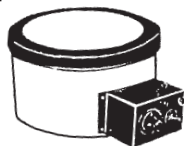

198

**WATER BATH FOR ROUND BOTTOM FLASK DOUBLE WALLED  
OUTSIDE BODY M.S., INSIDE S.S. THERMOSTATIC CONTROLLED**

| CAT. REF | CAP     | WATTS | PRICE /PC |
|----------|---------|-------|-----------|
| 198/01   | 2 Ltr.  | 1000  | 6800.00   |
| 198/02   | 5 Ltr.  | 1000  | 7900.00   |
| 198/03   | 10 Ltr. | 1500  | 9900.00   |
| 198/04   | 20 Ltr. | 2000  | 15500.00  |



199

**OIL BATH DOUBLE WALLED OUTSIDE BODY MS, INSIDE S.S.  
THERMOSTATIC CONTROLLED, ELECTRICALLY OPERATED**

| CAT. REF | CAP      | RATING KW | PRICE /PC |
|----------|----------|-----------|-----------|
| 199/01   | 1/2 Ltr. | 1.25      | 7900.00   |
| 199/02   | 3/5 Ltr. | 1.5       | 9800.00   |
| 199/03   | 10 Ltr.  | 2.0       | 16500.00  |



200

**MICROSCOPIC COVER GLASSES**

| CAT. REF | SIZE mm | PRICE/PC |
|----------|---------|----------|
| 200/01   | 18 X 18 | 85       |
| 200/02   | 19 X 19 | 85       |
| 200/03   | 22 X 22 | 85       |
| 200/04   | 24 X 24 | 90       |
| 200/05   | 25 X 25 | 90       |

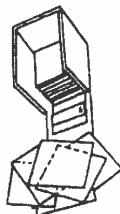



## 201 MICROSCOPIC GLASS SLIDES

| CAT. REF | QTY Per CASE | PRICE/PC |
|----------|--------------|----------|
| 201/01   | 50 slides    | 100      |



## 202 GLASS BEADS WITHOUT HOLE

| CAT. REF | DIA mm | PRICE/500 Gms |
|----------|--------|---------------|
| 202/01   | 3      | 450           |
| 202/02   | 4      | 450           |
| 202/03   | 5      | 525           |
| 202/04   | 6      | 525           |
| 202/05   | 7      | 525           |
| 202/06   | 8      | 550           |
| 202/07   | 10     | 550           |



## 203 RASCHING RINGS FOR PACKING COLUMNS NEUTRAL GLASS

| CAT. REF | DIA mm | HEIGHT mm | PRICE/KG. |
|----------|--------|-----------|-----------|
| 203/01   | 6      | 6         | 350       |
| 203/02   | 7      | 7         | 350       |
| 203/03   | 8      | 8         | 320       |
| 203/04   | 10     | 10        | 290       |
| 203/05   | 12     | 12        | 290       |
| 203/A06  | 15     | 15        | 280       |



## 204 WATCH GLASS, NEUTRAL GLASS

| CAT. REF | CAP. mm | PRICE/PC |
|----------|---------|----------|
| 204/01   | 50      | 7        |
| 204/02   | 65      | 9        |
| 204/03   | 75      | 12       |
| 204/04   | 100     | 15       |
| 204/05   | 125     | 24       |
| 204/06   | 150     | 28       |
| 204/07   | 200     | 65       |

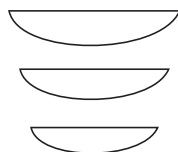



**205**  
**MORTER & PESTLE (PORCELAIN)**

| CAT. REF | DIA.<br>mm | PRICE/PC |
|----------|------------|----------|
| 205/01   | 60         | 42       |
| 205/02   | 75         | 54       |
| 205/03   | 100        | 108      |
| 205/04   | 125        | 170      |
| 205/05   | 150        | 225      |
| 205/06   | 200        | 470      |
| 205/07   | 250        | 1430     |
| 205/08   | 300        | 2450     |
| 205/09   | 350        | 4750     |
| 205/10   | 400        | 7650     |



**206**  
**MORTER & PESTLE (Indian Glass)**

| CAT. REF | DIA. mm | PRICE/PC |
|----------|---------|----------|
| 206/01   | 60      | 110      |
| 206/02   | 90      | 160      |
| 206/03   | 115     | 220      |
| 206/04   | 150     | 410      |



**207**  
**STALAGNOMETER GRADUATED**

| CAT. REF |               | PRICE/PC |
|----------|---------------|----------|
| 207/01   | STRAIGHT TYPE | 100      |
| 207/02   | BENT TYPE     | 120      |

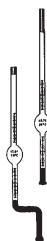

|   | PRICE/PC |
|---|----------|
| <b>208</b>                                |          |
| <b>208/1 ORGAN TUBE WITH SIDE TUBE</b>    | 95       |
| <b>208/2 ORGAN TUBE WITHOUT SIDE TUBE</b> | 75       |

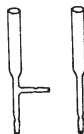

| <b>209</b>                         | PRICE/PC |
|------------------------------------|----------|
| <b>AERATION TUBE / OXYGEN TUBE</b> | 95       |



| <b>210</b>                   | PRICE/PC |
|------------------------------|----------|
| <b>210/1 CANNULAE SYME'S</b> | 50       |
| <b>210/2 CANNULAE VENOUS</b> | 40       |

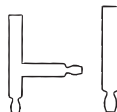



**211**  
**ARSENIC DETERMINATION APPARATUS WITH INDIAN GLASS BOTTLE**

| CAT. REF | CONSISTING OF :  | PRICE/SET |
|----------|--|-----------|
| 211/01   | 100 ml Bottle Wide Mouth and Arsenic Tube in Two Parts with Rubber Cock Metal Clip | 350       |



**212**  
**CHROMATOGRAPHY APPARATUS**

| CAT. REF | CONSISTING OF :  | PRICE/SET |
|----------|--|-----------|
| 212/01   | 100 ml B19 Socket Buchner Flask, Column 20 x 10 mm with Sintered Disc and B14 Socket and B19 Cone, Tap Funnel 50 ml, B14 Socket and Cone, Adapter Cone B14 | 1200      |



**213**  
**VACUUM DRYING PISTOL**

| CAT. REF | CONSISTING OF :   | PRICE/SET |
|----------|---|-----------|
| 213/01   | 100 ml R.B. Flask, Still head, Tap Adapter, Jacketed Tube 200 mm Coil Condenser R.B. Flask 250 ml | 3450      |

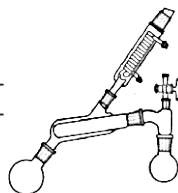

**214**  
**VACUUM SUBLIMATION ASSEMBLY**

| CAT. REF | CONSISTING OF :  | PRICE/SET |
|----------|--|-----------|
| 214/01   | Test Tube 28 x 200 mm Adapter with 'T' connection, Immersion Condenser | 510       |

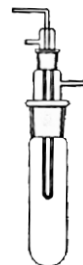



## 215 VOLATILE ACID DETERMINATION APPARATUS

| CAT. REF | CONSISTING OF :   | PRICE/SET |
|----------|---|-----------|
| 215/01   | Polenske and reichertmeisal for the determination of solute and insoluble Volatile acids in fat and oils.<br>For Analysis of butter and butter fats<br>Comprising of 300 ml. F.B. Flask,<br>Still Head, Condenser and Receiver<br>Flask Graduated at 100, 110 ml. | 2750.00   |

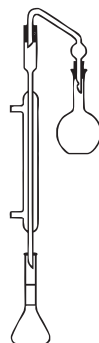

## 216 AMMONIA DISTILLING APPARATUS WITH GRAHAM CONDENSER

| CAT. REF | CONSISTING OF :   | PRICE/SET |
|----------|---|-----------|
| 216/01   | Used for determining nitrogen in organic compounds both the digestion and distillation stages can be performed in this apparatus. The assembly shown is the distillation stage where the amount of ammonia and hence nitrogen is established. The inlet tube allows the permanganate solution to be introduced after distillation, supplied with an outer I/C B 24 joint on the flask and an outer I/C B 19 joint on the condenser.<br>CAP 500 ml | 1350.00   |

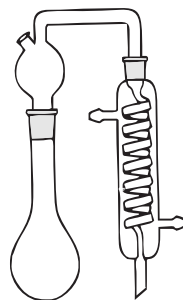

## 217 MICRO KJELDHAL DISTILLATION APPARATUS

| CAT. REF | CONSISTING OF :  | PRICE/SET |
|----------|--|-----------|
| 217/01   | Pregl's for determination on Nitrogen Automatic Discharge according to Parnes & Wanger, Complete with Silver Tube, Clamp, Stand & Burner | 6250.00   |

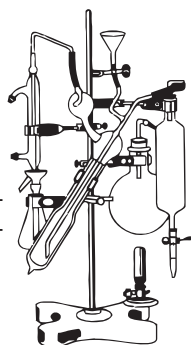



**218**  
**DISTILLATION ASSEMBLY.**

| CAT. REF                            |                                 |
|-------------------------------------|---------------------------------|
| 218/01                              | Consisting of :                 |
| Round Bottom Flask<br>1000 ml. B 24 | Air Condenser 4000 mm, B 24-24  |
| Splash Head Adapter<br>B 24-24      | Ether Condenser 400 mm. B 24-19 |
| Still Head B 24-24-24               | Conical Flask 500 ml, B 24.     |
| Thermometer B 14                    | Stopper B 19                    |

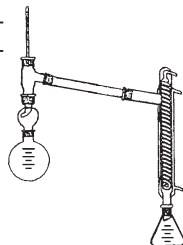

Rs. 5350.00 per set.

**219**  
**STOPPER HEXAGONAL INTERCHANGEABLE GROUND JOINT**

| CAT. REF | JOINT SIZE    | QTY Per CASE | PRICE/PC |
|----------|---------------|--------------|----------|
| 219/01   | B10           | 24           | 38       |
| 219/02   | B14           | 24           | 46       |
| 219/03   | B19           | 24           | 58       |
| 219/04   | B24           | 24           | 72       |
| 219/05   | B29           | 24           | 108      |
| 219/06   | B34           | 8            | 148      |
| 219/07   | B45 Flat Head | 8            | 350      |
| 219/08   | B55 Flat Head | 4            | 440      |



**220**  
**STOPPER HOLLOW PENNY HEAD 1/C GROUND JOINT**

| CAT. REF | JOINT SIZE | QTY Per CASE | PRICE/PC |
|----------|------------|--------------|----------|
| 220/01   | B10        | 24           | 40       |
| 220/02   | B14        | 24           | 46       |
| 220/03   | B19        | 24           | 62       |
| 220/04   | B24        | 24           | 72       |
| 220/05   | B29        | 24           | 105      |
| 220/06   | B34        | 8            | 135      |
| 220/07   | B45        | 8            | 230      |
| 220/08   | B55        | 4            | 270      |



**221**  
**GLASS SPRADERS TRIANGULAR BEND TYPE**

| CAT. REF                                  | PRICE/SET |
|---|-----------|
| 221/01 For Spreading Culture on Petridish | 60        |





**222**

**TRIPOD STAND, ROUND SHAPE HEAVY INDUSTRIAL TYPE**

| CAT. REF | DIA | HEIGHT | PRICE/PC |
|----------|-----|--------|----------|
| 222/01   | 150 | 225    | 300      |
| 222/02   | 200 | 150    | 400      |
| 222/03   | 250 | 350    | 700      |
| 222/04   | 300 | 400    | 900      |

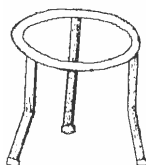

**223**

**TRIPOD STAND, TRIANGULAR SHAPE CAST IRON**

| CAT. REF | H x W inch | PRICE/PC |
|----------|------------|----------|
| 223/01   | 7 x 4      | 120      |
| 223/02   | 8 x 4      | 130      |
| 223/03   | 8 x 5      | 150      |

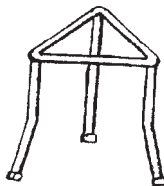

**224**

**BURETTE STAND CAST IRON WITH ROD**

| CAT. REF | PLATE SIZE | SIZE            | PRICE/PC |
|----------|------------|-----------------|----------|
|          | INCH       | DIA x LENGTH mm |          |
| 224/01   | 7" x 5"    | 12 x 450        | 270.00   |
| 224/02   | 8" x 5"    | 12 x 600        | 290.00   |
| 224/03   | 9" x 6"    | 12 x 750        | 410.00   |
| 224/04   | 12" x 7"   | 12 x 750        | 750.00   |

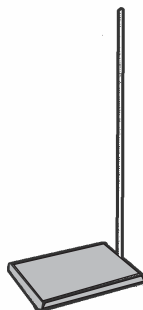

**225**

**BURETTE CLAMP, FISHER TYPE, (HOLDER)**

| CAT. REF | PRICE/PC |
|----------|----------|
| 225/01   | 110.00   |
| 225/02   | 190.00   |





**226**  
**THREE FINGER CLAMP**

| CAT. REF | SIZE INCH | PRICE/PC |
|----------|-----------|----------|
| 226/01   | 7         | 190      |
| 226/02   | 10        | 230      |
| 226/03   | 12        | 340      |

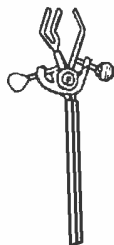

**227**  
**BOSS HEAD WITH DOUBLE KEY**

| CAT. REF | SIZE | PRICE/PC |
|----------|------|----------|
| 227/01   | 12mm | 80       |
| 227/02   | 16mm | 95       |
| 227/03   | 25mm | 170      |



**228**  
**CONDENSER & FLASK CLAMP WITHOUT BOSS HEAD**

| CAT. REF | SIZE INCH | PRICE/PC |
|----------|-----------|----------|
| 228/01   | 7         | 230      |
| 228/02   | 10        | 280      |
| 228/03   | 12        | 310      |

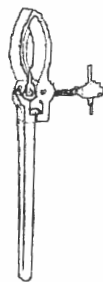

**229**  
**RETORT RINGS**

| CAT. REF | DIA mm | PRICE/PC |
|----------|--------|----------|
| 229/01   | 50     | 70       |
| 229/02   | 65     | 75       |
| 229/03   | 75     | 80       |
| 229/04   | 100    | 90       |
| 229/05   | 125    | 120      |
| 229/06   | 150    | 170      |
| 229/07   | 200    | 250      |

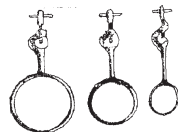



**230**  
**LABORATORY JACKS BOX TYPE HEAVY DUTY M.S.**

| CAT. REF | Size<br>mm | PRICE/PC |
|----------|------------|----------|
| 230/01   | 80 x 70    | 1250     |
| 230/02   | 120 x 140  | 1550     |
| 230/03   | 200 x 200  | 2800     |
| 230/04   | 250 x 250  | 3950     |
| 230/05   | 300 x 300  | 6250     |
| 230/06   | 350 x 350  | 12500    |

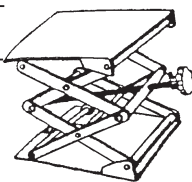

**231**  
**TEST TUBE STAND 2 TIRE ALUMINIUM**

| Size<br>Test Tube | Sr<br>No. | No. of Holes |      |      |      |      |       |
|-------------------|-----------|--------------|------|------|------|------|-------|
|                   |           | (12)         | (18) | (24) | (36) | (72) | (100) |
| 10 x 75           | 1         | 70           | 85   | 100  | 130  | 220  | 280   |
| 12 x 100          | 2         | 75           | 90   | 105  | 140  | 240  | 320   |
| 15 x 150          | 3         | 105          | 130  | 140  | 210  | 350  | 450   |
| 18 x 150          | 4         | 125          | 160  | 180  | 270  | 470  | 590   |
| 25 x 200          | 5         | 160          | 250  | 280  | 415  | 750  | --    |
| 32 x 200          | 6         | 220          | 300  | 440  | 670  | --   | --    |
| 38 x 200          | 7         | 250          | 400  | 510  | 720  | --   | --    |

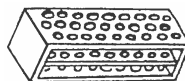

**232**  
**PRESSURE RUBBER TUBING (GREEN / RED COLOR)**  
**MINIMUM 10 MTR. ROLL**

| CAT. REF | BORE | WALL THICKNESS | PRICE PER 10 METER |
|----------|------|----------------|--------------------|
|          | mm   | mm             |                    |
| 232/01   | 3.0  | 3.0            | 290                |
| 232/02   | 4.5  | 3.0            | 360                |
| 232/03   | 6.0  | 3.0            | 430                |
| 232/04   | 8.0  | 3.0            | 510                |
| 232/05   | 9.0  | 3.0            | 570                |
| 232/06   | 10.0 | 3.5            | 810                |
| 232/07   | 12.5 | 4.5            | 1050               |





**233**

**SPATULAS, WITH ONE SIDE FLAT AND OTHER SIDE SPOON S.S.**

| CAT. REF | Length | S.S. PRICE/PIECE |
|----------|--------|------------------|
| 233/01   | 100mm  | 22.00            |
| 233/02   | 125mm  | 28.00            |
| 233/03   | 150mm  | 35.00            |
| 233/04   | 200mm  | 42.00            |
| 233/05   | 250mm  | 55.00            |
| 233/06   | 300mm  | 100.00           |

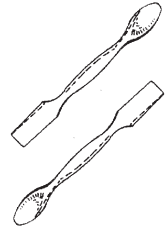

**234**

**SPATULA MICRO S.S.**

| CAT. REF | SIZE mm (FLAT) | PRICE/PC | CAT. REF | SIZE mm (SPOON) | PRICE/PC |
|----------|----------------|----------|----------|-----------------|----------|
| 234/01   | 125            | 28       | 234/04   | 125             | 33       |
| 234/02   | 150            | 36       | 234/05   | 150             | 40       |
| 234/03   | 200            | 48       | 234/06   | 200             | 50       |



**235**

**TONGS CRUCIBLES IRON (PAIR OF TONG)**

| CAT. REF | SIZE INCH | QTY Per CASE | PRICE/PC |
|----------|-----------|--------------|----------|
| 235/01   | 6         | 12           | 80       |
| 235/02   | 8         | 12           | 100      |
| 235/03   | 10        | 12           | 145      |
| 235/04   | 12        | 12           | 250      |



**236**

**TEST TUBE HOLDER**

| CAT. REF                      | PRICE/SET |
|-------------------------------|-----------|
| 236/01 Polished Wooden Handle | 25        |



**237**

**LOOP HOLDER**

| CAT. REF                                     | PRICE/SET |
|--|-----------|
| 237/01 Straight S.S. with Nichrome Loop wire | 50        |





**238**  
**WIRE GAUZES**

| CAT. REF | SIZE INCH | QTY Per CASE | PRICE/PC |
|----------|-----------|--------------|----------|
| 238/01   | 6 x 6     | 12           | 16       |
| 238/02   | 8 x 8     | 12           | 40       |
| 238/03   | 10 x 10   | 12           | 60       |
| 238/04   | 12 x 12   | 12           | 90       |

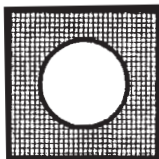

**239**  
**BUNSEN BURNER BRASS**

| CAT. REF                 | PRICE/SET |
|--------------------------|-----------|
| 239/01 Without stop cock | 250       |
| 239/02 With stop cock    | 410       |

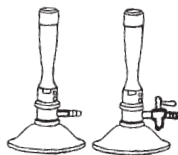

**240**  
**HOFFMAN SCREW CLIP BRASS NICKEL PLATED**

| CAT. REF | SIZE MM | QTY Per CASE | PRICE/PC |
|----------|---------|--------------|----------|
| 240/01   | 12.5    | 12           | 80       |
| 240/02   | 25.0    | 12           | 100      |
| 240/03   | 50.0    | 12           | 280      |

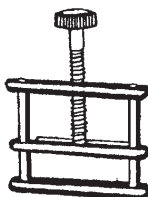

**241**  
**WATER BATH COPPER WITH CENTRE RING**

| CAT. REF | SIZE MM | QTY Per CASE | PRICE/PC |
|----------|---------|--------------|----------|
| 241/01   | 100     | 12           | 700      |
| 241/02   | 150     | 12           | 750      |
| 241/03   | 200     | 12           | 950      |

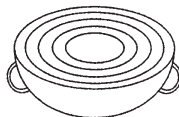

**242**  
**PINCH CLIP**

| CAT. REF                               | PRICE/SET |
|--|-----------|
| 242/01 For Compressing flexible tubing | 14        |





**243**  
**RUBBER BULB FOR AUTOMATIC BURETTES (SINGLE BELLOW)**

| CAT. REF |  | PRICE/SET |
|----------|--|-----------|
| 243/01   | Convenient for use on wash bottles,<br>Sprayers & Automatic Burettes | 85        |

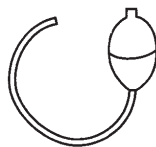

**244**  
**PIPETTE BULB RUBBER RED COLOUR**

| CAT. REF | CAP ML | PRICE/PC |
|----------|--------|----------|
| 244/01   | 1 TO 5 | 15       |
| 244/02   | 10     | 20       |
| 244/03   | 15     | 23       |
| 244/04   | 25     | 38       |
| 244/05   | 50     | 56       |
| 244/06   | 100    | 65       |



**245**  
**RUBBER ADAPTOR FOR FILTER FLASK**

| CAT. REF | CAP ML    | PRICE/PC |
|----------|-----------|----------|
| 245/01   | 250 & 500 | 90       |
| 245/02   | 1000      | 110      |
| 245/03   | 2000      | 110      |
| 245/04   | 5000      | 140      |
| 245/05   | 10000     | 170      |
| 245/06   | 20000     | 170      |



**246**  
**RUBBER CONES**

| CAT. REF | SIZE MM | PRICE/PC |
|----------|---------|----------|
| 246/01   | 12      | 20       |
| 246/02   | 16      | 22       |
| 246/03   | 19      | 27       |
| 246/04   | 25      | 40       |



**247**  
**TISSUE PAPER ROLL**

| CAT. REF | PRICE/ROLL |
|----------|------------|
| 247/01   | 70         |



## 248 RUBBER CORKS

| CAT. REF | SIZE MM  | PRICE/PC |
|----------|----------|----------|
| 248/01   | 1 & 2    | 4        |
| 248/02   | 3 & 4    | 6        |
| 248/03   | 5, 6 & 7 | 10       |
| 248/04   | 8 & 9    | 12       |
| 248/05   | 10 & 11  | 18       |
| 248/06   | 12 & 13  | 22       |
| 248/07   | 14 & 15  | 24       |
| 248/08   | 16 & 17  | 25       |
| 248/09   | 18 & 19  | 32       |
| 248/10   | 20       | 40       |
| 248/11   | 21 & 22  | 52       |
| 248/12   | 23 & 24  | 70       |



## 249 RBC PIPETTE

| CAT. REF |                            | PRICE/SET |
|----------|----------------------------|-----------|
| 249/01   | With latex and mouth piece | 190       |



## 250 WBC PIPETTE

| CAT. REF |                            | PRICE/SET |
|----------|----------------------------|-----------|
| 250/01   | With latex and mouth piece | 190       |



## 251 DIGITAL STOP WATCH

| CAT. REF |                    | PRICE/SET |
|----------|--------------------|-----------|
| 251/01   | Digital 1/100 SEC. | 650       |



## 252 FILTER PAPER 500 SHEETS (REAM)

| CAT. REF | SIZE        | PRICE/PC |
|----------|-------------|----------|
| 252/01   | 46 x 57 cms | 1750     |
| 252/02   | 58 x 58 cms | 2450     |





**253**

**AMPULES NEUTRAL GLASS PACK OF 1000 PCS**

| CAT. REF | CAP ML | PRICE/PC |
|----------|--------|----------|
| 253/01   | 2      | 1800     |
| 253/02   | 5      | 2200     |
| 253/03   | 10     | 3200     |



**254**

**AMPULES AMBER NEUTRAL GLASS PACK OF 1000 PCS**

| CAT. REF | CAP ML | PRICE/PC |
|----------|--------|----------|
| 254/01   | 2      | 2100     |
| 254/02   | 5      | 2900     |
| 254/03   | 10     | 4000     |



**255**

**IMPINGER GRADUATED FOR AIR SAMPLING**

| CAT. REF | CAP ML | PRICE/PC |
|----------|--------|----------|
| 255/01   | 35     | 190      |
| 255/02   | 50     | 290      |
| 255/03   | 75     | 300      |
| 255/04   | 100    | 390      |
| 255/05   | 150    | 540      |
| 255/06   | 250    | 700      |
| 255/07   | 275    | 850      |



**256**

**BALANCE ELECTRONIC**

| CAT. REF | CAP. gm | Readability gm | PRICE on Request |
|----------|---------|----------------|------------------|
| 256/01   | 100     | 0.1            | "                |
| 256/02   | 200     | 0.1            | "                |
| 256/03   | 300     | 0.1            | "                |
| 256/04   | 500     | 0.1            | "                |
| 256/05   | 1000    | 0.1            | "                |

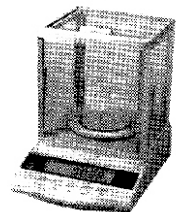



**257**  
**TOP SCALE ELECTRONIC**

| CAT. REF | CAP. Kg | Accuracy gm | PRICE on Request |
|----------|---------|-------------|------------------|
| 257/01   | 2       | 1           | "                |
| 257/02   | 3       | 1           | "                |
| 257/03   | 5       | 1           | "                |



**258**  
**CLAY PIPE TRIANGLES PORCELAIN**

| CAT. REF | CAP mm | PRICE/SET |
|----------|--------|-----------|
| 258/01   | 50     | 20        |
| 258/02   | 60     | 30        |
| 258/03   | 75     | 40        |



**259**  
**MICRO PIPETTES FIXED VOLUME**

| CAT. REF | VOLUME $\mu$ l | PRICE/PC |
|----------|----------------|----------|
| 259/01   | 5.0            | 2150     |
| 259/02   | 10.0           | 2150     |
| 259/03   | 25.0           | 2250     |
| 259/04   | 50.0           | 2250     |
| 259/05   | 100.0          | 2250     |
| 259/06   | 250.0          | 2350     |
| 259/07   | 500.0          | 2350     |



**260**  
**MICRO PIPETTES VARIABLE VOLUME**

| CAT. REF | VOLUME $\mu$ l | PRICE/PC |
|----------|----------------|----------|
| 260/01   | 0.5-10         | 3850     |
| 260/02   | 10-100         | 3850     |
| 260/03   | 5-50           | 3850     |
| 260/04   | 2-20           | 3850     |
| 260/05   | 20-200         | 3850     |
| 260/06   | 100-1000       | 4250     |
| 260/07   | 0.5-5 ml.      | 5750     |
| 260/08   | 1-10 ml.       | 5750     |



## 261

### EVAPORATING BASIN (CHINA DISHES) PORCELAIN

| CAT. REF | DIA MM | CAP ML | PRICE/PC |
|----------|--------|--------|----------|
| 261/01   | 50     | 30     | 42       |
| 261/02   | 75     | 80     | 48       |
| 261/03   | 85     | 125    | 54       |
| 261/04   | 100    | 175    | 62       |
| 261/05   | 110    | 250    | 86       |
| 261/06   | 125    | 450    | 115      |
| 261/07   | 150    | 600    | 164      |

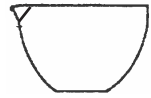

## 262

### TRAYS, ENAMEL WITHOUT COVER

| CAT. REF | SIZE INCH | PRICE/PC |
|----------|-----------|----------|
| 262/01   | 6X8       | 240      |
| 262/02   | 8X10      | 335      |
| 262/03   | 10X12     | 490      |
| 262/04   | 12X15     | 840      |
| 262/05   | 12X18     | 1000     |
| 262/06   | 15X18     | 1150     |
| 262/07   | 18X24     | 1390     |

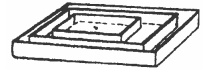

## 263

### HAND GLOVES, ASBESTOS

| CAT. REF | SIZE INCH | PRICE/PC |
|----------|-----------|----------|
| 263/01   | 12        | 254      |
| 263/02   | 14        | 268      |
| 263/03   | 16        | 296      |
| 263/04   | 18        | 355      |
| 263/05   | 22        | 410      |



## 264

### HAND GLOVES, RUBBER

| CAT. REF | SIZE INCH | PRICE/PC |
|----------|-----------|----------|
| 264/01   | 12        | 124      |
| 264/02   | 14        | 135      |
| 264/03   | 16        | 160      |
| 264/04   | 18        | 190      |
| 264/05   | 22        | 240      |





**265  
COUPLING JAR**

| CAT. REF |       | PRICE |
|----------|-------|-------|
| 265/01   | Glass | 110   |
| 265/02   | P.P.  | 44    |



**266  
VACUUM PUMP SINGLE STAGE / DOUBLE STAGE**

| CAT. REF |                 | PRICE on Request |
|----------|-----------------|------------------|
| 266/01   | Water Ring Type | "                |
| 266/02   | Oil Ring Type   | "                |
| 266/03   | Oil Free (Dry)  | "                |
| 266/04   | Diaphragm Type  | "                |

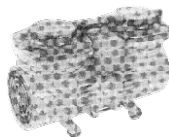

**267  
FORCEPS STRAIGHT / BLUNT S.S.**

| CAT. REF | SIZE MM | PRICE |
|----------|---------|-------|
| 267/01   | 125     | 60    |
| 267/02   | 150     | 84    |
| 267/03   | 200     | 130   |
| 267/04   | 250     | 180   |



**268  
SPRING BALANCE**

| CAT. REF | SIZE   | PRICE |
|----------|--------|-------|
| 268/01   | 100 gm | 65    |
| 268/02   | 250 gm | 75    |
| 268/03   | 500 gm | 80    |
| 268/04   | 1 kg.  | 90    |



**269  
VERNIER CALLIPERS**

| CAT. REF | SIZE INCH | PRICE |
|----------|-----------|-------|
| 269/01   | 5         | 110   |
| 269/02   | 6         | 310   |
| 269/03   | 8         | 650   |
| 269/04   | 10        | 810   |
| 269/05   | Digital   | 3000  |

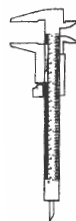



**270  
HAEMOCYTOMETER**

| CAT. REF |              | PRICE/PC |
|----------|--------------|----------|
| 270/01   | Complete Set | 2000     |

**271  
E.S.R. TUBE**

| CAT. REF |  | PRICE/PC |
|----------|--|----------|
| 271/01   |  | 90       |

**272  
E.S.R. STAND**

| CAT. REF |        | PRICE/PC |
|----------|--------|----------|
| 272/01   | 6 Hole | 450      |

**273  
PH PAPER**

| CAT. REF |      | PRICE/PKT |
|----------|------|-----------|
| 273/01   | 0-10 | 150       |
| 273/02   | 0-14 | 170       |

**274  
CLIP FOR SPHERICAL BALL & SOCKET JOINTS**

| CAT. REF | JOINT SIZE | PRICE/PC |
|----------|------------|----------|
| 274/01   | S-13       | 105      |
| 274/02   | S-19       | 120      |
| 274/03   | S-29       | 160      |
| 274/04   | S-35       | 220      |
| 274/05   | S-41       | 450      |
| 274/06   | S-51       | 550      |





# INDUSTRIAL GLASSWARE PARTS

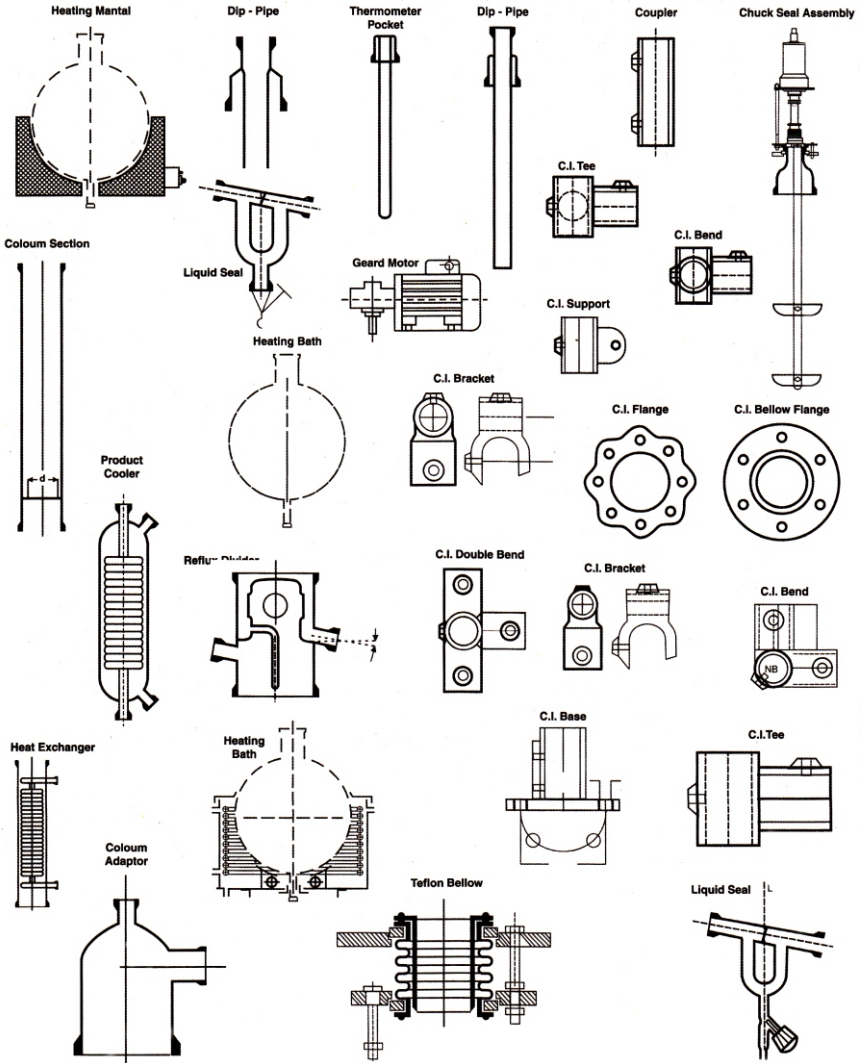



## ◆ TERMS & CONDITIONS ◆

- ✓ The Prices are ex-works Baroda and subject to market fluctuations.
- ✓ Alterations can be made without any prior notice.
- ✓ Packing, forwarding, freight and insurance will be charged Extra.
- ✓ Estimated packing cost is 3% of the bill value.
- ✓ VAT / CST as per Govt. rules will be charged Extra.
- ✓ Order is accepted on 40% advanced payment and the remaining against delivery.
- ✓ The company will not be responsible for any breakage or loss in transit.
- ✓ While placing orders, Please quote price list no. for immediate delivery.
- ✓ Road permit, If applicable, will have to be supplied by consignee well in advance.
- ✓ All disputes are subject to Baroda jurisdictions only.

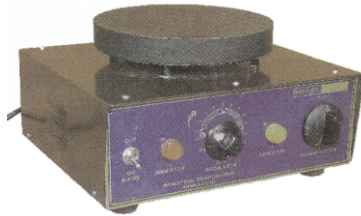



## SHREE SAI SCIENTIFIC

A-37/A, B/h Sakar Complex, Sardar Estate, Vadodara-390 019.

**T** 0265 - 2514122 **M** 989 855 3025

**E** shreesaiscientific@gmail.com **W** www.shreesaiscientific.in